Cedar Forest Products

www.cedarforestproducts.com
800.552.9495



Wood Shelters ▪ Band Shells ▪ Steel Shelters ▪ Restrooms
Park & Camp Buildings ▪ Bridges ▪ Site Amenities





For over 50 years, Cedar Forest Products (CFP) has been designing and creating shelters for public and private parks, camps and recreation facilities. CFP offers prefabricated and engineered products including: park pavilions, gazebos, bridges, pergolas, kiosks, cedar cabins, cedar homes and cedar multi-use facilities. Choose from standard designs or create one that is custom. All products are designed to perform and built to last.





Contents

Wood Shelters

Information, Details & Options	Pages 4-5
Low Pitch Beam	Page 6
Gothic Arch	Page 7
Hexagon Post & Beam	Page 8
Octagon Post & Beam	Page 9
Hexagon/Octagon Arch	Page 10
Open Timber Truss.....	Page 11
Timber Truss.....	Page 12
Wood Hip	Page 13
Summerhaven Gazebo	Page 14
Mini.....	Page 15
Pergola	Pages 16-17
Custom Wood Shelters.....	Pages 18-19

Band Shells

Information, Details & Options	Pages 20-21
Band Shell 1 & 2	Page 22
Band Shell 3 & 4	Page 23

Steel Shelters

Information, Details & Options	Pages 24-25
Rectangular Open Gable.....	Page 26
Rectangular Hip	Page 27
Barrel Vault.....	Page 28
Hexagon Steel.....	Page 29
Octagon Steel	Page 30
Mini.....	Page 31
Sports Shelters	Page 32
Pergola	Page 33
Custom Steel Shelters	Pages 34-35

Park & Camp Buildings

Information, Details & Options	Pages 36-39
Parkaire Buildings	Pages 40-43
Hexagon/Octagon Post & Beam Restroom.....	Pages 44-45
Gothic Arch Restroom	Pages 46-47
Lodge Buildings	Pages 48-50
Cabins	Pages 51-53

Bridges..... Pages 54-55

Site Amenities

Color Options & Selections..... Pages 58-59

Wood Shelters



Since 1964, Cedar Forest Products has been supplying wood shelters and pavilions to meet the wide ranging needs of its customers. CFP uses glue-laminated timber, or glulam, as it is a highly innovative construction material. Pound for pound, glulam is stronger than steel and has greater strength and stiffness than comparably sized dimensional lumber. The natural beauty of wood helps to enrich the landscape in any setting.

Standard Features

Pre-Engineered Designs

- Each shelter is pre-engineered to meet or exceed local building requirements
- Stamped and sealed drawings and calculations completed by a structural engineer to meet a project's state and local building codes

Structure Frame

- Glulam Southern Yellow Pine (SYP)
- Each shelter is designed to meet the local snow and wind loads
- All metal connectors have a factory applied powder coat finish in Railing Black

Columns

- Port Orford Cedar columns – direct embedded in concrete footings
- Port Orford Cedar provides superior resistance against rot and decay

Roofing

- #1 grade, kiln dried 2" x 6" SYP roof decking
- 2" x 8" Western Red Cedar fascia
- 30-year architectural grade shingle package

Optional Features

Color options and selections shown on page 58.



Cedar Roof Decking
#1 grade, kiln dried 2" x 6"
Alaskan Yellow Cedar



Cedar Shingles
Can be used on most
shelters



Metal Roofing
29 gauge max rib or 26
gauge standing seam
roofing packages

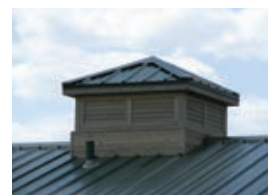

Cupola
Prefabricated cupolas can
be added to most shelters



Cedar Glulam Frame
Alaskan Yellow Cedar can
be used on most shelter
frames



Steel Columns
Powder coated steel
columns



Metal Base Shoes
Powder coated shoes for
surface mount



Ornamentation
Prebuilt cedar handrails
and decorative wood
ornamentation



Roof Pitches
Shelters can be designed
with custom roof pitches



Factory Finish
Clear coat sealer and color
stain options



Lightning Protection
Lightning rods, cable and
grounding equipment



Customization
Custom sizes and features



Low Pitch Beam

Overall dimensions include a 24" overhang, glulam Port Orford Cedar columns, glulam SYP beams, #1 grade, kiln dried 2" x 6" SYP roof decking, 2" x 8" Western Red Cedar fascia, 30-year architectural grade shingle package, powder coated brackets, galvanized hardware, 3:12 roof pitch

Standard Sizes

Low Pitch Beam	Roof Size	Low Pitch Beam	Roof Size
LB1620	16 x 20	LB3044	30 x 44
LB1628	16 x 28	LB3052	30 x 52
LB1636	16 x 36	LB3060	30 x 60
LB2020	20 x 20	LB3068	30 x 68
LB2028	20 x 28	LB4044	40 x 44
LB2036	20 x 36	LB4052	40 x 52
LB2044	20 x 44	LB4060	40 x 60
LB2052	20 x 52	LB4068	40 x 68
LB2428	24 x 28	LB4076	40 x 76
LB2436	24 x 36	LB4084	40 x 84
LB2444	24 x 44	LB5052	50 x 52
LB2452	24 x 52	LB5068	50 x 68
LB2460	24 x 60	LB5076	50 x 76
LB3036	30 x 36	LB5084	50 x 84

Options: Cedar Roof Decking • Cedar Shingles • Metal Roofing • Cupola • Cedar Glulam Frame • Steel Columns • Metal Base Shoes • Ornamentation • Roof Pitches • Factory Finish • Lightning Protection • Customization



Gothic Arch

Glulam SYP arches and purlins, #1 grade, kiln dried 2" x 6" SYP roof decking, 2" x 8" Western Red Cedar fascia, 30-year architectural grade shingle package, powder coated metal base shoes, 4:12 roof pitch

Standard Sizes

Gothic Arch	Roof Size
GAP2444	24 x 44
GAP2452	24 x 52
GAP2836	28 x 36
GAP2844	28 x 44
GAP2852	28 x 52
GAP3444	34 x 44
GAP3452	34 x 52
GAP4460	44 x 60



Options: Cedar Roof Decking • Cedar Shingles • Metal Roofing • Cupola • Cedar Glulam Frame • Ornamentation • Roof Pitches • Factory Finish • Lightning Protection • Customization • Closed or Open Arches



Hexagon Post & Beam

Glulam Port Orford Cedar columns, glulam SYP beams and purlins, #1 grade, kiln dried 2" x 6" SYP roof decking, 2" x 8" Western Red Cedar fascia, 30-year architectural grade shingle package, powder coated brackets, galvanized hardware, 3:12 roof pitch

Standard Sizes			
Hexagon Post & Beam	Roof Diameter	Hexagon Post & Beam	Roof Diameter
HPB16	16'	HPB35	35'
HPB20	20'	HPB36	36'
HPB24	24'	HPB40	40'
HPB30	30'	HPB45	45'
HPB32	32'	HPB50	50'

Options: Cedar Roof Decking • Cedar Shingles • Metal Roofing • Cupola • Cedar Glulam Frame • Steel Columns • Metal Base Shoes • Ornamentation • Roof Pitches • Factory Finish • Lightning Protection • Customization • Knee Braces



Octagon Post & Beam

Glulam Port Orford Cedar columns, glulam SYP beams and purlins, #1 grade, kiln dried 2" x 6" SYP roof decking, 2" x 8" Western Red Cedar fascia, 30-year architectural grade shingle package, powder coated brackets, galvanized hardware, 3:12 roof pitch

Standard Sizes	
Octagon Post & Beam	Roof Diameter
OPB26	26'
OPB30	30'
OPB34	34'
OPB36	36'
OPB40	40'
OPB45	45'
OPB60	60'



Options: Cedar Roof Decking • Cedar Shingles • Metal Roofing • Cupola • Cedar Glulam Frame • Steel Columns • Metal Base Shoes • Ornamentation • Roof Pitches • Factory Finish • Lightning Protection • Customization • Knee Braces



Hexagon/Octagon Arch

Glulam SYP arches, beams and purlins, #1 grade, kiln dried 2" x 6" SYP roof decking, 30-year architectural grade shingle package, powder coated metal base shoes, 4:12 roof pitch

Standard Sizes

Hexagon Arch	Roof Diameter	Octagon Arch	Roof Diameter
HAP20	20'	OAP18	18'
HAP24	24'	OAP24	24'
HAP28	28'	OAP28	28'
HAP34	34'	OAP34	34'
HAP36	36'	OAP40	40'
		OAP44	44'

Options: Cedar Roof Decking • Cedar Shingles • Metal Roofing • Cupola • Cedar Glulam Frame • Ornamentation • Roof Pitches • Factory Finish • Lightning Protection • Customization • Closed or Open Arches



Open Timber Truss

Overall dimensions include a 24" overhang, glulam Port Orford Cedar columns, glulam SYP trusses, #1 grade, kiln dried 2" x 6" SYP roof decking, 30-year architectural grade shingle package, knee braces are standard but shelter can be designed without them, 4:12 roof pitch

Standard Sizes			
Open Timber Truss	Roof Size	Open Timber Truss	Roof Size
OTT1620	16 x 20	OTT2844	28 x 44
OTT1628	16 x 28	OTT2852	28 x 52
OTT2028	20 x 28	OTT3444	34 x 44
OTT2036	20 x 36	OTT3452	34 x 52
OTT2428	24 x 28	OTT3460	34 x 60
OTT2436	24 x 36	OTT3476	34 x 76
OTT2444	24 x 44	OTT4460	44 x 60
OTT2836	28 x 36		



Options: Cedar Roof Decking • Cedar Shingles • Metal Roofing • Cupola • Cedar Glulam Frame • Steel Columns • Metal Base Shoes • Ornamentation • Roof Pitches • Factory Finish • Lightning Protection • Customization • Split Gable Design



Timber Truss

Overall dimensions include a 24" overhang, glulam Port Orford Cedar columns, glulam SYP trusses, #1 grade, kiln dried 2" x 6" SYP roof decking, 2" x 8" Western Red Cedar fascia, 30-year architectural grade shingle package, knee braces are standard but shelter can be designed without them, enclosed wood gable ends, 4:12 roof pitch

Standard Sizes

Timber Truss	Roof Size	Timber Truss	Roof Size
TT1620	16 x 20	TT2844	28 x 44
TT1628	16 x 28	TT2852	28 x 52
TT2028	20 x 28	TT3444	34 x 44
TT2036	20 x 36	TT3452	34 x 52
TT2428	24 x 28	TT3460	34 x 60
TT2436	24 x 36	TT3476	34 x 76
TT2444	24 x 44	TT4460	44 x 60
TT2836	28 x 36		

Options: Cedar Roof Decking • Cedar Shingles • Metal Roofing • Cupola • Cedar Glulam Frame • Steel Columns • Metal Base Shoes • Ornamentation • Roof Pitches • Factory Finish • Lightning Protection • Customization • Dropped Wood Ceiling • Knee Braces



Wood Hip

Glulam Port Orford Cedar columns, glulam SYP beams and purlins, #1 grade, kiln dried 2" x 6" SYP roof decking, 2" x 8" Western Red Cedar fascia, 30-year architectural grade shingle package, 3:12 roof pitch

Standard Sizes

Wood Hip	Roof Size
WH1212	12 x 12
WH1616	16 x 16
WH2020	20 x 20
WH2424	24 x 24
WH2828	28 x 28
WH3232	32 x 32
WH3636	36 x 36
WH4040	40 x 40



Options: Cedar Roof Decking • Cedar Shingles • Metal Roofing • Cupola • Cedar Glulam Frame • Steel Columns • Metal Base Shoes • Ornamentation • Roof Pitches • Factory Finish • Lightning Protection • Customization



Summerhaven Gazebo

Glulam Port Orford Cedar columns, glulam SYP hip rafters, beams and purlins, #1 grade, kiln dried 2" x 6" SYP roof decking, 30-year architectural grade shingle package, prefabricated cupola, decorative top railings, 8:12 roof pitch

Standard Sizes

Summerhaven Gazebo	Roof Diameter
SH12	12'
SH16	16'
SH20	20'
SH26	26'
SH28	28'
SH36	36'

Options: Cedar Roof Decking • Cedar Shingles • Metal Roofing • Cedar Glulam Frame • Steel Columns • Metal Base Shoes • Roof Pitches • Factory Finish • Lightning Protection • Customization



Mini

Glulam Port Orford Cedar columns, glulam SYP beams and rafters, #1 grade, kiln dried 2" x 6" SYP roof decking, 30-year architectural grade shingle package, Western Red Cedar fascia, benches, tables or message center included, 4:12 roof pitch

Standard Sizes			
Mini	Roof Size	Mini	Roof Size
MB8 (bench)	8 x 8	MB10 (bench)	10 x 10
MT8 (table)	8 x 8	MT10 (table)	10 x 10
MBB8 (message)	8 x 8	MBB10 (message)	10 x 10



Options: Cedar Roof Decking • Cedar Shingles • Metal Roofing • Cedar Glulam Frame • Steel Columns • Metal Base Shoes • Ornamentation • Roof Pitches • Factory Finish • Customization • Enclosed Outdoor Display Case



Formal Pergola: Large 10" x 10" posts, stout brackets and plinth bases



Traditional Pergola: 6" x 6" solid cedar posts and curved brackets



Shade Mesh: White stained pergola employing an 80% white shade mesh for added sun protection

Pergola

Custom pergolas are fabricated based on either a client's submitted concepts or the designs created by an architect or contractor. The kits are constructed of the finest grade Western Red Cedar: kiln dried, vertical grain, A and better, clear coastal grown. All hardware is included. Pergolas are designed with function, aesthetics and budget in mind. Below are some standard styles and functions for CFP's pergola structures.

STYLES

Formal/Tuscan
Contemporary
Traditional
Asian
Mission
Cantilevered

FUNCTIONS

Shade Protection
Kitchen Pergola
Large Span Pergola
Rooftop Structures
Carport
Commercial Setting

Options: Wood Posts • Aluminum Posts • Fiberglass Columns • Privacy Panels • Trellised Posts • Parasoleil Panels

Contemporary Pergola



Simple, clean modern structure with louvered rafters for added shade



A dramatic pergola employing aluminum posts and beams supporting a dense rafter layout in quadrants

Curved Pergola



Cantilever structure with curved purlins which mirror the patio railing below



Unique cantilevered kitchen pergola which eliminates posts in the sitting and traffic areas

Large Area Pergola



Large 18' x 36' pergola which frames several parasoleil panels providing shade and interesting patterns on the patio



Carport pergola created to span up to 22'; also employs privacy lattice panels that are freestanding and used as a visual divider



Custom Wood Shelters



Cedar Forest Products has many years of experience creating various wood structures. Whether a standard shelter needs a few custom touches or a complete custom build, CFP can help design a solution that will meet a project's needs. Here are examples of CFP's many custom projects.



Band Shells



Open band shells are a perfect spot for community gatherings. CFP's versatile band shells combine beauty with function. Several of the four standard designs feature dressing rooms, storage space or walls to enclose the graceful Gothic arch style frame. An important acoustical property of wood is its ability to damp vibrations. Cedar is particularly effective at sound insulation and absorption when utilized properly and can help confine noise to certain areas. CFP can customize any band shell or completely create a design to suit any number of community entertainment events, performances and festivals.

Standard Features

Pre-Engineered Designs

- Each band shell is pre-engineered to meet or exceed local building requirements
- Stamped and sealed drawings and calculations completed by a structural engineer to meet a project's state and local building codes

Structure Frame

- Glulam Southern Yellow Pine (SYP)
- Each shelter is designed to meet the local snow and wind loads
- All metal connectors have a factory applied powder coat finish in Railing Black

Columns

- Gothic arch style, glue-laminated SYP columns are either direct embedded in concrete footings or attached at the surface utilizing metal base shoes

Walls

- Band Shell 1, 3 and 4 have nominal 5" x 8" decorative grade cedar walls
- Band Shell 2 walls are 2" x 6" select grade cedar

Roofing

- #1 grade, kiln dried 2" x 6" SYP roof decking
- 2" x 8" Western Red Cedar fascia
- 30-year architectural grade shingle package

Optional Features

Color options and selections shown on page 58.



Metal Base Shoes

Powder coated shoes for surface mount



Lightning Protection

Lightning rods, cable and grounding equipment



Metal Roofing

29 gauge max rib or 26 gauge standing seam roofing packages



Factory Finish

Clear coat sealer and color stain options



Ornamentation

Pre-built cedar handrails and decorative wood ornamentation



Customization

Custom sizes and features



Roof Pitches

Shelters can be designed with custom roof pitches



Cedar Roof Decking

#1 grade, kiln dried 2" x 6" Alaskan Yellow Cedar



Cedar Shingles

Can be used on most shelters



Cedar Glulam Frame

Alaskan Yellow Cedar can be used on most shelter frames



Additional Enclosures

Dressing room(s), storage or restrooms



Band Shell 1

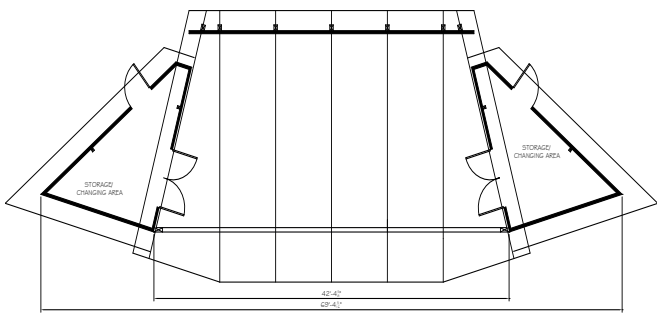

69' x 27'



Band Shell 2

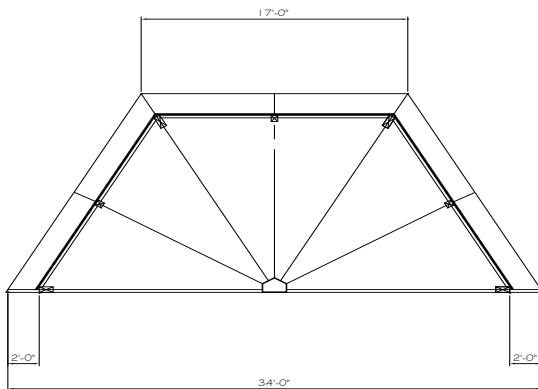

34' x 15'



Band Shell 3

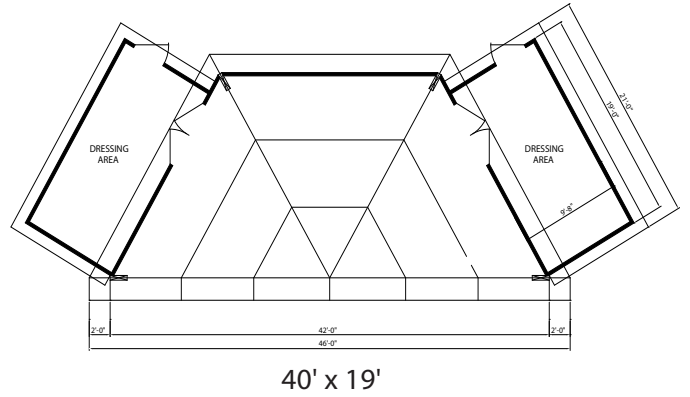

Band Shell 4

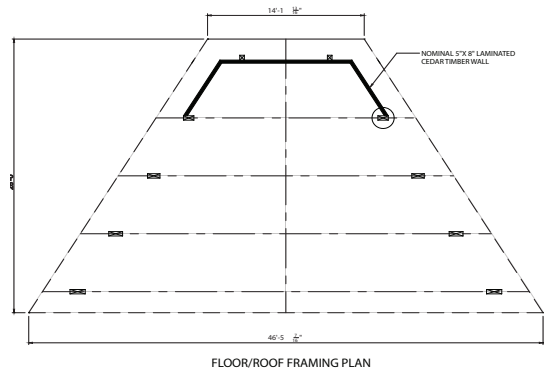

Steel Shelters



Steel shelters by Cedar Forest Products offer a practical solution with elegant simplicity. Their classic designs can easily be adapted and customized to suit any environment. CFP's steel shelters make for a fine addition to any park without sacrificing affordability. Decades of skill and experience go into every one of CFP's durable steel structures. The modern design conceals all bolts and fasteners where possible. People love their versatility and ease of installation. All steel structures are precut, prefabricated and shipped as components of a complete building package, no onsite welding is required.

Standard Features

Pre-Engineered Designs

- Each shelter is pre-engineered to meet or exceed local building requirements
- Stamped and sealed drawings and calculations completed by a structural engineer to meet a project's state and local building codes

Structure Frame

- Tubular steel frame utilizes hidden bolt and fasteners where possible
- Each shelter is designed to meet the local snow and wind loads
- Frame comes with a durable powder coat finish

Roofing

- 24 gauge multi-rib metal roofing with a Kynar 500 color finish
- Mega rib metal roofing with a Kynar 500 color finish on Barrel Vault structures only
- Trim and fasteners included

Optional Features

Color options and selections shown on page 59.



Roof Decking

#1 grade, kiln dried 2" x 6" SYP roof decking



Finish Roofing

Choose from standing seam or 30-year architectural grade shingles



Roof Pitches

Shelters can be designed with custom roof pitches



Shelter Tiers

Two and three-tiered structures are available



Cupola

Prefabricated cupolas can be added on to most shelters



Ornamentation

Choose from 4 standard or custom handrail and overhead ornamentation



Laser Cut Medallions

Custom medallions can be added



Column Style

Custom designs are available



Metal Base Covers

Powder coated metal cover for exposed metal base plates



Electrical Access & Cutouts

Predrilled electrical chase and receptacle openings can be added



Lightning Protection

Lightning rods, cable and grounding equipment



Customization

Custom sizes and features



Rectangular Open Gable

Single-tier, double-tier and split gable options available, 24 gauge metal roofing, factory applied powder coat finish on all steel components, 4:12 roof pitch

Standard Sizes			
Rectangular Open Gable	Roof Size	Rectangular Open Gable	Roof Size
ROGS1624	16 x 24	ROGS2434	24 x 34
ROGS1634	16 x 34	ROGS2444	24 x 44
ROGS1644	16 x 44	ROGS2464	24 x 64
ROGS2024	20 x 24	ROGS3044	30 x 44
ROGS2034	20 x 34	ROGS3064	30 x 64
ROGS2044	20 x 44	ROGS3084	30 x 84

Options: Roof Decking • Finish Roofing • Roof Pitches • Shelter Tiers • Cupola • Ornamentation • Laser Cut Medallions • Column Style • Metal Base Covers • Electrical Access & Cutouts • Lightning Protection • Customization



Rectangular Hip

Single-tier and double-tier options available, 24 gauge metal roofing, factory applied powder coat finish on all steel components, 4:12 roof pitch



Standard Sizes			
Rectangular Hip	Roof Size	Rectangular Hip	Roof Size
RHS1212	12 x 12	RHS2424	24 x 24
RHS1616	16 x 16	RHS2434	24 x 34
RHS1624	16 x 24	RHS2444	24 x 44
RHS1634	16 x 34	RHS2464	24 x 64
RHS1644	16 x 44	RHS3030	30 x 30
RHS2020	20 x 20	RHS3044	30 x 44
RHS2024	20 x 24	RHS3064	30 x 64
RHS2034	20 x 34	RHS3084	30 x 84
RHS2044	20 x 44	RHS3636	36 x 36

Options: Roof Decking • Finish Roofing • Roof Pitches • Shelter Tiers • Cupola • Ornamentation • Laser Cut Medallions • Column Style • Metal Base Covers • Electrical Access & Cutouts • Lightning Protection • Customization



Barrel Vault

One or two-tiered models available, 24 gauge metal roofing, factory applied powder coat finish on all steel components

Standard Sizes			
Barrel Vault	Roof Size	Barrel Vault	Roof Size
BV1624	16 x 24	BV2434	24 x 34
BV1634	16 x 34	BV2444	24 x 44
BV1644	16 x 44	BV2464	24 x 64
BV2024	20 x 24	BV3044	30 x 44
BV2034	20 x 34	BV3064	30 x 64
BV2044	20 x 44	BV3084	30 x 84

Options: Roof Decking • Shelter Tiers • Ornamentation • Laser Cut Medallions • Column Style • Metal Base Covers • Electrical Access & Cutouts • Lightning Protection • Customization



Hexagon Steel

One or two-tiered models available, 24 gauge metal roofing, factory applied powder coat finish on all steel components, 4:12 roof pitch

Standard Sizes			
Hexagon Steel	Roof Diameter	Hexagon Steel	Roof Diameter
HSP16	16'	HSP36	36'
HSP20	20'	HSP40	40'
HSP24	24'	HSP50	50'
HSP28	28'		



Options: Roof Decking • Finish Roofing • Roof Pitches • Shelter Tiers • Cupola • Ornamentation • Laser Cut Medallions • Column Style • Metal Base Covers • Electrical Access & Cutouts • Lightning Protection • Customization



Octagon Steel

One or two-tiered models available, 24 gauge metal roofing, factory applied powder coat finish on all steel components, 4:12 roof pitch



Standard Sizes

Octagon Steel	Roof Diameter	Octagon Steel	Roof Diameter
OSP16	16'	OSP36	36'
OSP20	20'	OSP40	40'
OSP24	24'	OSP50	50'
OSP28	28'		

Options: Roof Decking • Finish Roofing • Roof Pitches • Shelter Tiers • Cupola • Ornamentation • Laser Cut Medallions • Column Style • Metal Base Covers • Electrical Access & Cutouts • Lightning Protection • Customization



Mini Steel

24 gauge metal roofing, factory applied powder coat finish on all steel components, benches, tables or message center included, 4:12 roof pitch

Standard Sizes			
Mini Steel	Roof Size	Mini Steel	Roof Size
MBS8 (bench)	8' x 8'	MBS10 (bench)	10' x 10'
MTS8 (table)	8' x 8'	MTS10 (table)	10' x 10'
MBBS8 (message)	8' x 8'	MBBS10 (message)	10' x 10'



Options: Roof Decking • Finish Roofing • Roof Pitches • Laser Cut Medallions • Column Style • Metal Base Covers • Electrical Access & Cutouts • Customization



Sports Shelters

The increase in healthy lifestyles has created higher demand for sports shelters in many park facilities. CFP's sports shelters can be used as bleacher covers or dugouts creating shade and weather protection for players and fans. Custom sizes for sports shelters are available.

24 gauge metal roofing, factory applied powder coat finish on all steel components, benches are optional, 3:12 roof pitch

Standard Sizes			
Dugout	Roof Size	Bleacher Cover	Roof Size
D24	8' x 24'	BC810	8' x 10'
D28	8' x 28'	BC820	8' x 20'
D32	8' x 32'	BC830	8' x 30'
		BC1220	12' x 20'
		BC1230	12' x 30'
		BC1620	16' x 20'
		BC1630	16' x 30'

Options: Roof Decking • Finish Roofing • Roof Pitches • Laser Cut Medallions • Column Style • Metal Base Covers • Electrical Access & Cutouts • Customization



Pergola

Cedar Forest Products offers a variety of steel pergola styles. Certified welders and craftsmen create a tubular steel frame utilizing clear-span design. Pergolas are shipped ready to assemble with no cutting or welding required. A factory applied powder coat finish is standard on all steel components. Due to the wide variety of options such as columns, supporting beams and members, pergolas are custom in nature, allowing for many designs and sizes. Various beam details including scalloped headers and curved beam options allow for dramatic architectural statements. CFP can create a pergola to fit a project's specific needs.

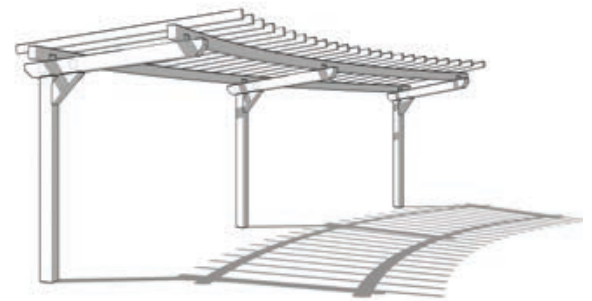
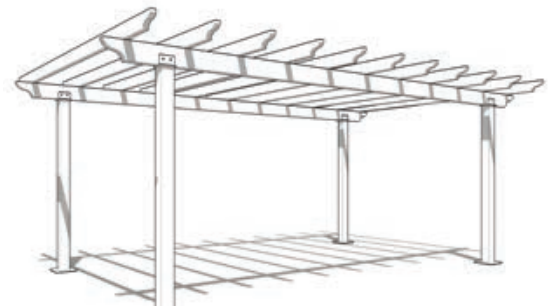
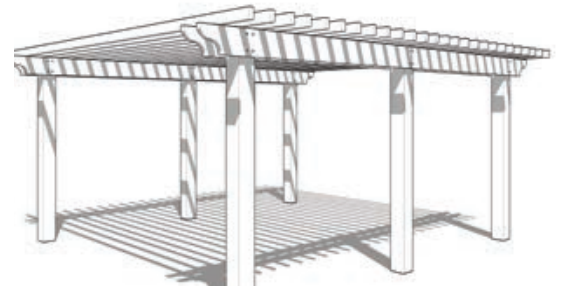

Options: Roof Pitches • Shelter Tiers • Ornamentation • Laser Cut Medallions • Column Style • Metal Base Covers • Electrical Access & Cutouts • Customization



Custom Steel Shelters



Cedar Forest Products has many years of experience creating various steel structures. Whether a standard shelter needs a few custom touches or a complete custom build, CFP can help design a solution that will meet a project's needs. Here are examples of CFP's many custom projects.



Park & Camp Buildings



Cedar Forest Products offers a variety of timber wall buildings. Standard buildings are available or CFP's design services can be used to match a structure to an organization's exact needs. CFP utilizes its Cedar Wall System for Parkaire activity centers, park cabins, lodge buildings and many other multi-use buildings. All wall components are preassembled and construction coded to assure a perfect fit, then dismantled and delivered to the job site. All structures include engineered drawings and installations instructions. Each building is designed for durability and years of comfort and service.

Standard Features

Pre-Engineered Designs

- Each shelter is pre-engineered to meet or exceed local building requirements
- Stamped and sealed drawings and calculations completed by a structural engineer to meet a project's state and local building codes
- Restroom facilities meet ADA compliance requirements

Cedar Walls

- Precut, preassembled and construction coded to ensure a perfect fit
- Disassembled and delivered to the construction site
- Made using decorative-grade Western Red Cedar or Northern White Cedar both known for their natural beauty, durability and structural integrity
- Cedar is highly desirable for its resistance to moisture warpage, insects and fungus that can shorten the service life of other wood buildings
- Cedar's cellular structure also offers a natural thermal efficiency

Exterior Wall Construction

- Nominal 5" x 8" double tongue and groove timbers are used for exterior wall construction
- Dovetail corners augment construction strength, reliability and weather seal
- Predrilled starter holes for 10" coated screws spaced at 30" intervals speed wall construction
- Timbers are cut to length assuring staggered end joints and end matched for precision assembly
- Timbers can be predrilled for electrical conduit
- Electrical outlets are preplanned to meet the project's needs and can be specified for any location
- Choice of corner styles: Rustic, Log Cabin or Salem Square, see page 58 for options

Roofing

- #1 grade, kiln dried 2" x 6" SYP roof decking
- 2" x 8" Western Red Cedar fascia
- 30-year architectural grade shingle package

Doors, windows and skylights

- Items are shipped to the job site ready for installation

Park and Camp Buildings

Packages and Options

Cedar Forest Products offers plumbing and electrical fixture packages for all Park and Camp buildings. These packages provide all of the fixtures needed to complete the project. They do not include the wiring or conduit. The packages need to be installed by a local plumbing or electrical contractor. HVAC can be added to buildings using a local HVAC contractor.

Plumbing Fixture Packages

- Choice of stainless steel or vitreous china plumbing fixtures
- Plumbing fixtures are normally wall mounted to interior stud walls
- Designs typically allow for an open chase behind the wall for easy maintenance
- Interior walls have a Fiberglass Reinforced Panel (FRP) in the restroom areas for easy cleaning
- Interior multipurpose walls to be finished onsite with provided 1" x 8" cedar or pine paneling
- Standard packages can include: tank-less water heater, sanitary disposal, soap dispenser, wall hydrant and items listed below



Sinks
Choice of stainless steel or vitreous china



Toilets
Choice of stainless steel or vitreous china



Urinals
Choice of stainless steel or vitreous china



Restroom Toilet Partitions
Per plan



Toilet Paper Dispensers
Per plan

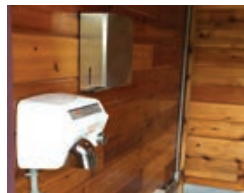

Paper Towel Dispensers or Hand Dryers
Per plan



Signs
Per plan

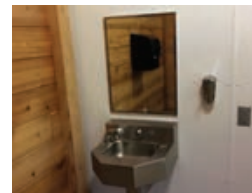

Mirrors
Per plan

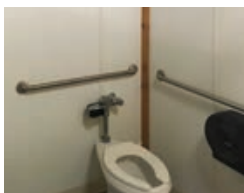

Grab Bars
Per plan



Waste Receptacles
Per plan



Drinking Fountains
Optional



Baby Changing Stations
Optional

Electrical Fixture Packages



**Light Fixtures,
Bases and Lamps**
Per plan



**Outlets or GFCI
Outlets**
Per plan



Breaker Boxes
Per plan



**Overhead HMC
Light Sensors**
Per plan

Optional Features

Color options and selections shown on page 58.



**Steel Exterior Doors
(single or double)**
All hardware included



Windows
Per plan, additional
windows may be added



Display Case
Can be added to most
buildings



**Roll-up Concession
Window**
All hardware included



Garage Doors
All hardware included



Metal Roofing
29 gauge max rib or 26
gauge standing seam
roofing packages



Cupola
Prefabricated cupolas can
be added



Factory Finish
Clear coat sealer and color
stain options



Lighting Protection
Lightning rods, cable and
grounding equipment



Customization
Custom sizes and features



Parkaire Activity Center

The Parkaire Activity Center (PAC) can serve as staff offices, concession stands, restroom facilities or storage. The PAC series features standard floor plans, but can be modified to fit a project's specific needs. The shelter bay can be increased or decreased in 8' bay increments. This versatile building can be used in a variety of different ways. The standard building features can be found on page 37.

Standard Sizes		
PAC	Roof Size	Enclosed Area
PAC 1	20' x 36'	16' x 8'
PAC 2	20' x 44'	16' x 16'
PAC 3	30' x 44'	26' x 18'
PAC 4	40' x 68'	36' x 40'
PAC 5	30' x 44'	26' x 16'
PAC 6	30' x 68'	26' x 24'
PAC 7	44' x 68'	40' x 16'
PAC 8	40' x 68'	36' x 24'
PAC 9	34' x 60'	30' x 32'
PAC 10	34' x 84'	30' x 29'

Options: Steel Exterior Doors • Windows • Display Case • Roll-up Concession Window • Garage Doors • Metal Roofing • Cupola • Skylights • Factory Finish • Lightning Protection • Metal Base Shoes • Steel Columns • Plumbing Packages • Electrical Packages • Drinking Fountain • Customization

Parkaire Activity Center Restroom Layouts

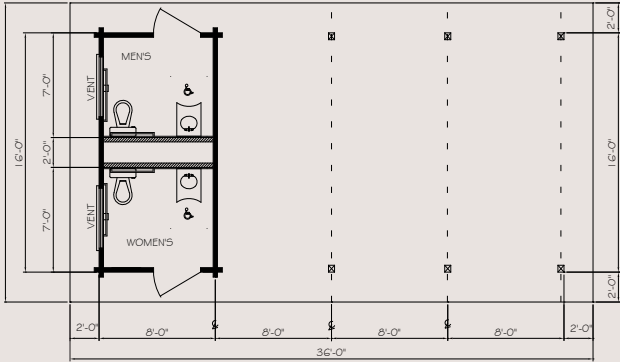

PAC 1 20' x 36' with 16' x 8' enclosed

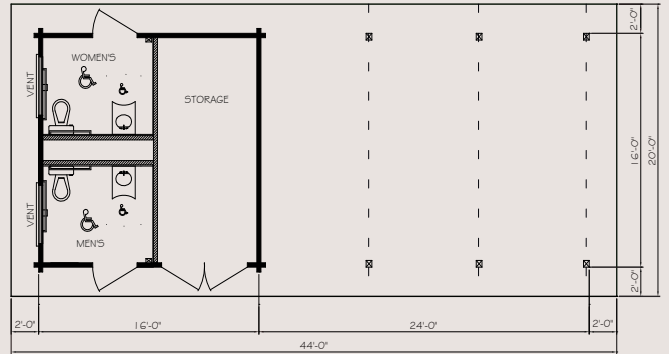

PAC 2 20' x 44' with 16' x 16' enclosed

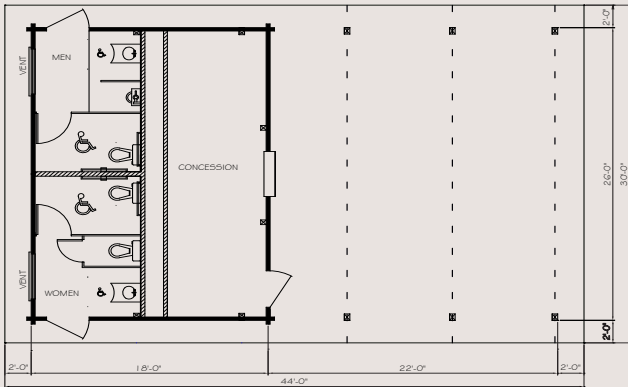

PAC 3 30' x 44' with 26' x 18' enclosed

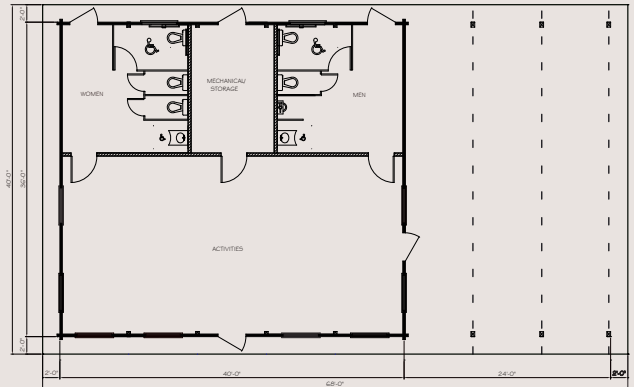

PAC 4 40' x 68' with 36' x 40' enclosed

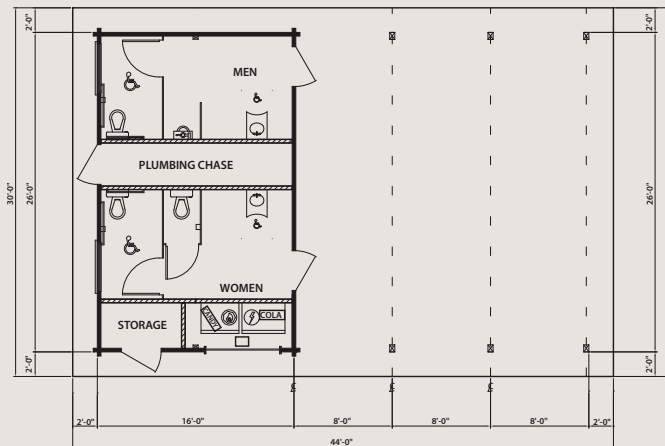

PAC 5 30' x 44' with 26' x 16' enclosed

Parkaire Activity Center Restroom Layouts

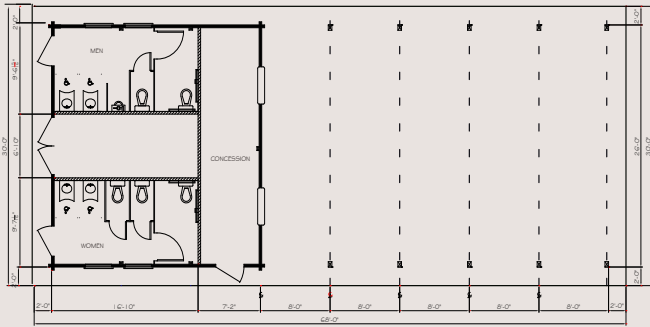

PAC 6 30' x 68' with 26' x 24' enclosed

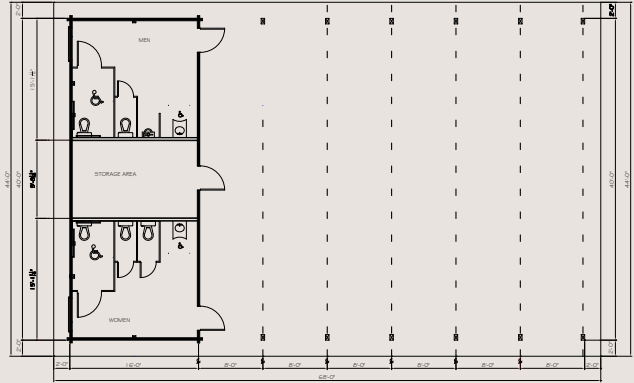

PAC 7 44' x 68' with 40' x 16' enclosed

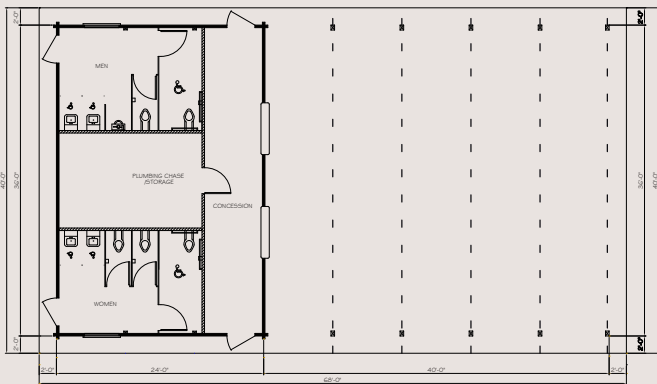

PAC 8 40' x 68' with 36' x 24' enclosed

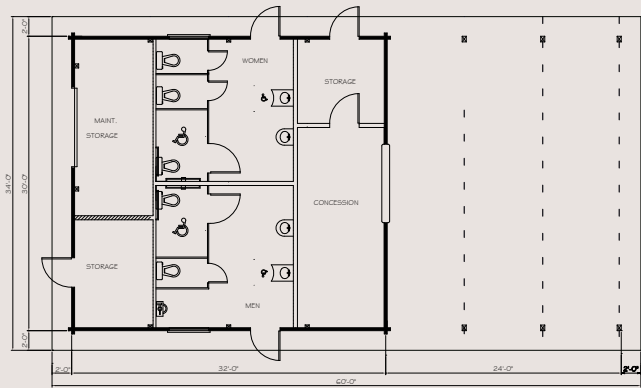

PAC 9 34' x 60' with 30' x 32' enclosed

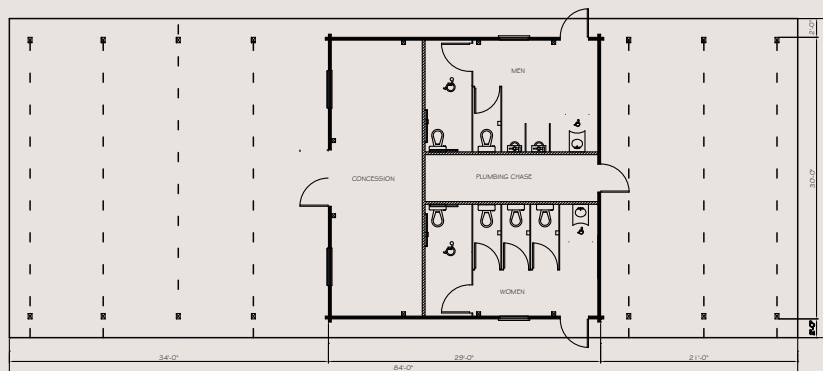

PAC 10 34' x 84' with 30' x 29' enclosed



Parkaire Standalone Restroom

CFP can manufacture Parkaire Activity Centers as enclosed buildings without an attached open picnic shelter. The Parkaire Standalone Restroom (PSR) was created from the growing demand for an economical restroom, concession or storage space on a smaller footprint. PSR buildings can be created from any of CFP's standard Parkaire designs. The standard building features can be found on page 37.

Standard Sizes

PSR 1 20' x 12' with 16' x 8' Enclosed

PSR 2 20' x 20' with 16' x 16' Enclosed

Standalone restrooms can be configured on other CFP designs.



Options: Steel Exterior Doors • Windows • Display Case • Roll-up Concession Window • Garage Doors • Metal Roofing • Cupola • Skylights • Factory Finish • Lightning Protection • Plumbing Packages • Electrical Packages • Drinking Fountain • Customization



Hexagon/Octagon Post & Beam Restroom

The combination of post and beam construction offers inviting economy in a hexagon or octagon open shelter shape. The Hexagon/Octagon Post and Beam Restroom facility (HRF/ORF) has many uses and makes for a great focal point in a ball field complex. The small shelter bay can be used for vending or an information center. Both octagon and hexagon models may also be designed as enclosed buildings. The standard building features can be found on page 37.

Standard Sizes			
Hexagon Restroom	Roof Diameter	Octagon Restroom	Roof Diameter
HRF20	20'	ORF20	20'
HRF24	24'	ORF24	24'
HRF30	30'	ORF30	30'
HRF35	35'		
HRF45	45'		

Options: Steel Exterior Doors • Windows • Display Case • Roll-up Concession Window • Garage Doors • Metal Roofing • Cupola • Skylights • Factory Finish • Lightning Protection • Metal Base Shoes • Steel Columns • Plumbing Packages • Electrical Packages • Drinking Fountain • Customization

Hexagon & Octagon Restroom Layouts

Hexagon Restrooms

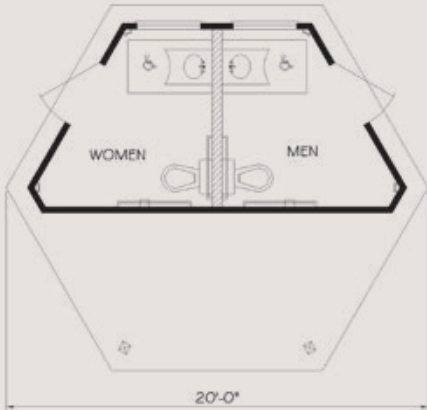

HRF 20

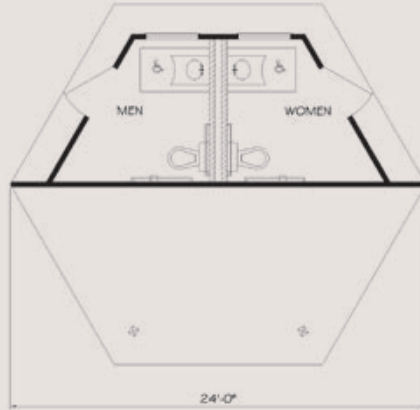

HRF 24

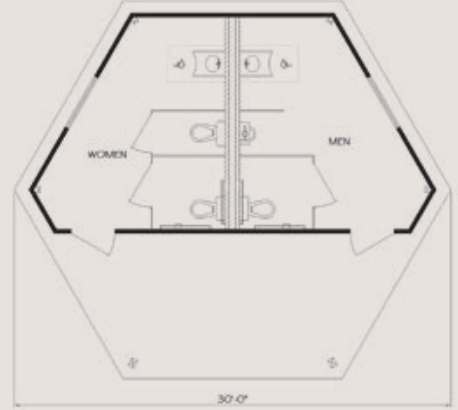

HRF 30

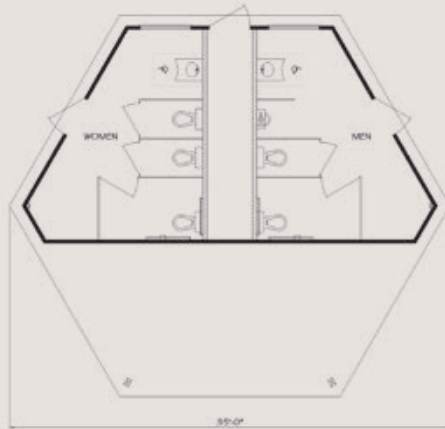

HRF 35

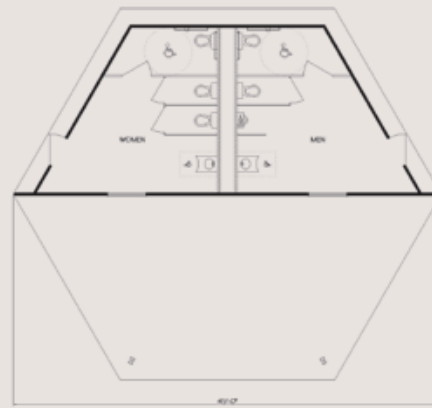

HRF 45

Octagon Restrooms

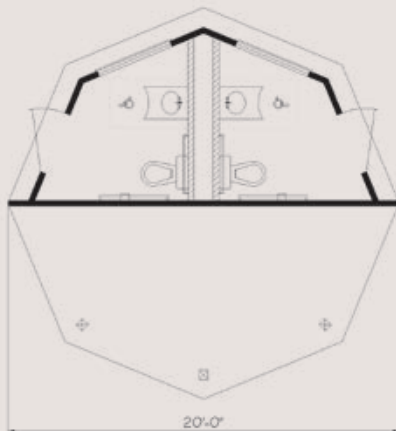

ORF 20

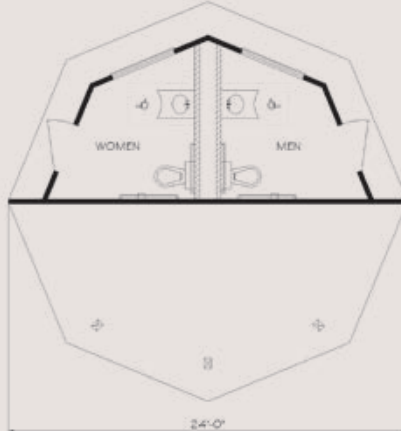

ORF 24

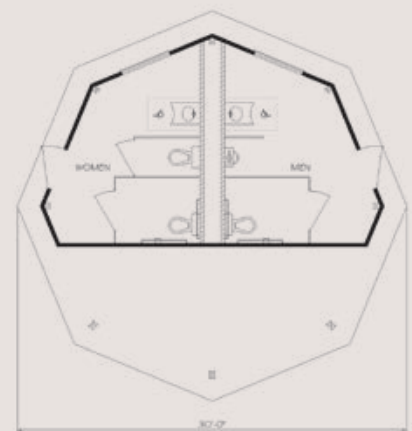

ORF 30



Gothic Arch Restroom

The Gothic Arch Restroom (GAR) combines traditional architecture with strength and durability. Its versatility, combined with striking looks, continues to be a favorite choice for parks and camps. Enclose the space as required and custom design the use to the project's needs. The standard building features can be found on page 37.

Standard Sizes		
Gothic Arch Restroom	Roof Size	Enclosed Area
GAR2444	24' x 44'	20' x 8'
GAR2648	26' x 48'	22' x 12'
GAR2840	28' x 40'	24' x 12'
GAR2844	28' x 44'	24' x 18'
GAR2868	28' x 68'	24' x 24'
GAR3028	30' x 28'	26' x 16'
GAR3440	34' x 40'	30' x 12'
GAR3444	34' x 44'	30' x 18'
GAR3464	34' x 64'	30' x 20'

Options: Steel Exterior Doors • Windows • Display Case • Roll-up Concession Window • Garage Doors • Metal Roofing • Cupola • Skylights • Factory Finish • Lightning Protection • Metal Base Shoes • Plumbing Packages • Electrical Packages • Drinking Fountain • Customization

Gothic Arch Restroom Layouts

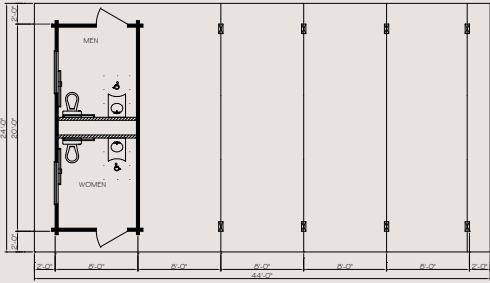

GAR2444 24' x 44' with 20' x 8' Enclosed

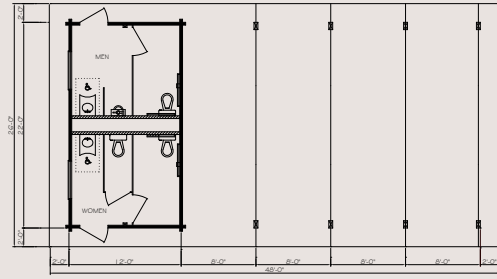

GAR2648 26' x 48' with 22' x 12' Enclosed

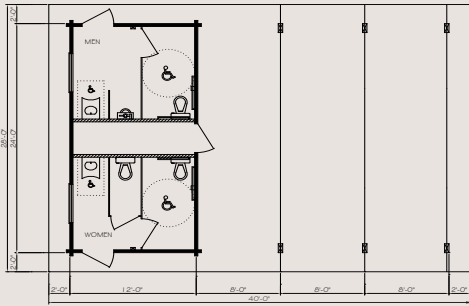

GAR2840 28' x 40' with 24' x 12' Enclosed

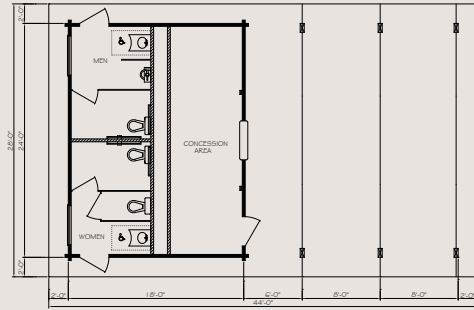

GAR2844 28' x 44' with 24' x 18' Enclosed

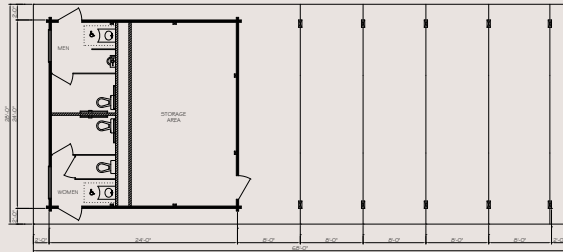

GAR2868 28' x 68' with 24' x 24' Enclosed

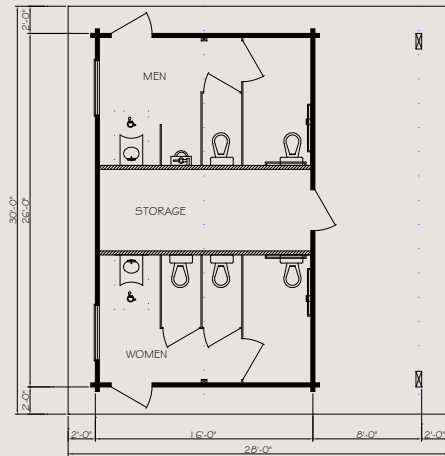

GAR3028 30' x 28' with 26' x 16' Enclosed

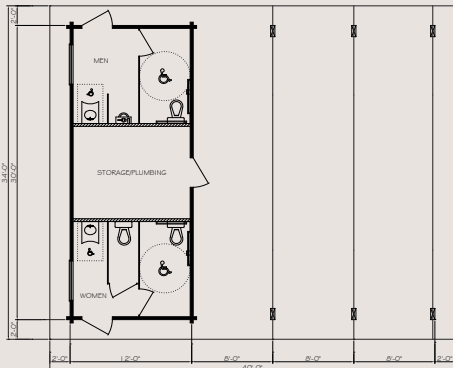

GAR3440 34' x 40' with 30' x 12' Enclosed

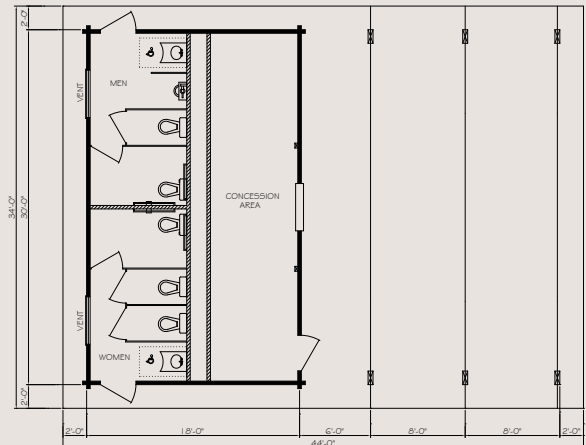

GAR3444 34' x 44' with 30' x 18' Enclosed

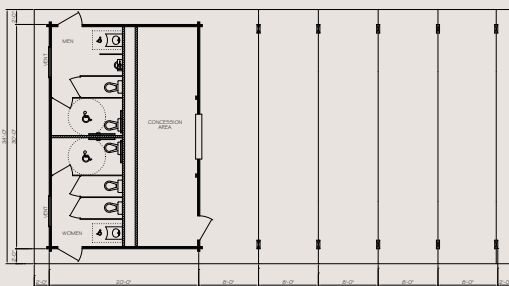

GAR3464 34' x 64' with 30' x 20' Enclosed



Penfield

The versatile Penfield was engineered to serve the Air Force on its Northern Michigan base. Some of the many features include a front glass prow with large windows, a spacious activity center and kitchen as well as complete restroom facilities. Custom floor plans are available.

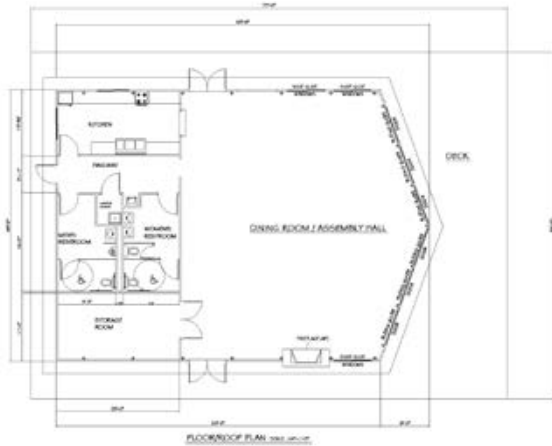

Wesley Acres

Wesley Acres was constructed for Dakota Methodist Church Camps. Offering a 4,500 sq. ft. multifunctional floor plan that can be used for weddings or other large gatherings, it can comfortably seat 120 people. Restrooms, dining hall and large food prep kitchen make this a perfect spot for group events. Custom floor plans are available.

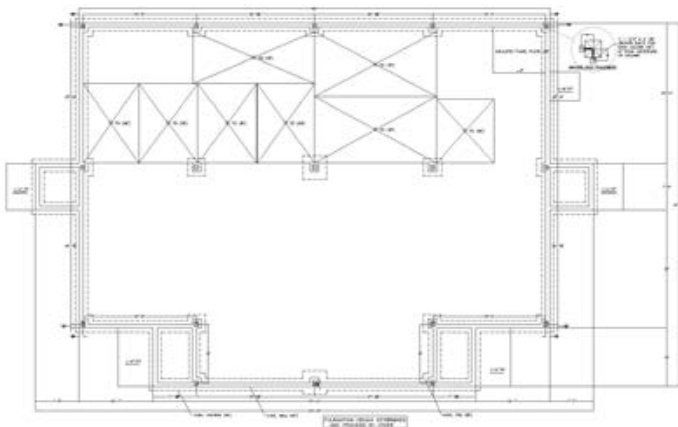

Jester Park

The one-story, 7,000 sq. ft. Jester Park epitomizes smart design and incredible craftsmanship. A full kitchen, dance floor, large gathering space, and restrooms are some of the many features this multiuse building offers. Custom floor plans are available.

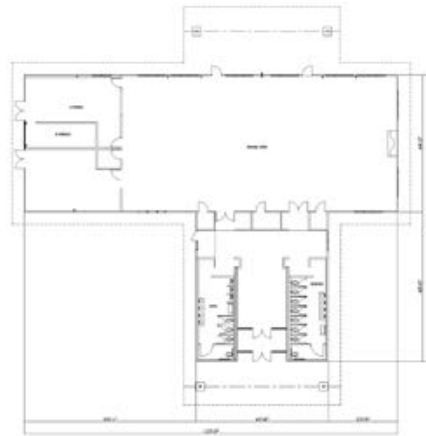

Bradford

The Bradford is a stunning example of a park district golf pro shop, food service, office or mezzanine building. With a total of 3,200 sq. ft., full kitchen, restroom facilities and meeting spaces, the Bradford can serve a variety of meeting needs. Custom floor plans are available.

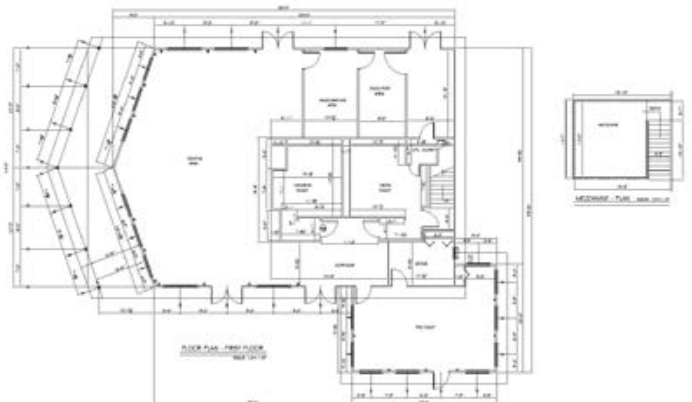



Reception Center

The Reception Center is a tribute to Frank Lloyd Wright which is characterized by a low profile, horizontal expression. The simple and functional plan has 1,000 sq. ft. of balcony space with benches, restrooms, office space and a large gathering area. Custom floor plans are available.



Interpretive Center

A total of 3,000 sq. ft., the Interpretive Center was designed for the New Jersey Park and Forestry Division. It offers ample floor space and lots of natural lighting from the full-view open gable front. Custom floor plans are available.

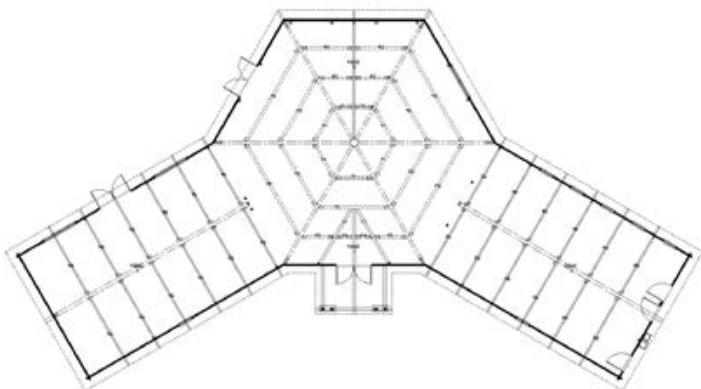



Cabins

CFP's park cabins are ideal for camps or anyone returning to nature. Cedar Forest Products has designed many cabin projects for county and state park systems, municipal and private camps. The craftsmanship of CFP's larger buildings can also be found in the cabins. Each one is durably designed for years of comfort and service.

All standard packages come complete with pre-cut and construction coded 5" x 8" cedar exterior timber walls, steel insulated doors, aluminum clad insulated windows, pre-engineered roof trusses, 5/8" APA rated plywood roof sheathing, 30-year architectural grade shingles, 30# felt, 2" x 4" interior wall framing, 3/8" FRP panels for restroom walls, 1" x 8" cedar paneling for all other interior walls and all hardware needed to install supplied materials.



Options: Cedar Roof Decking • Cedar Shingles • Metal Roofing • Plumbing Packages • Electrical Packages • Custom Floor Plans • Lightning Protection System • Covered Porches • Roof Pitches

Cabin Layouts

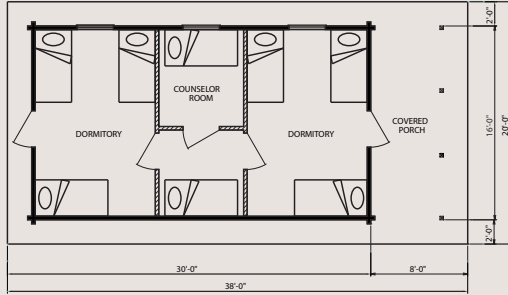

Buckhorn: 16' x 20', 480 sq. ft.

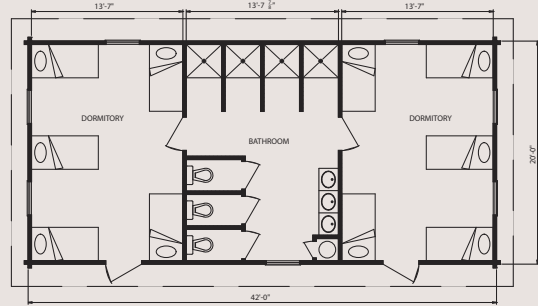

Carrington: 20' x 42', 840 sq. ft.

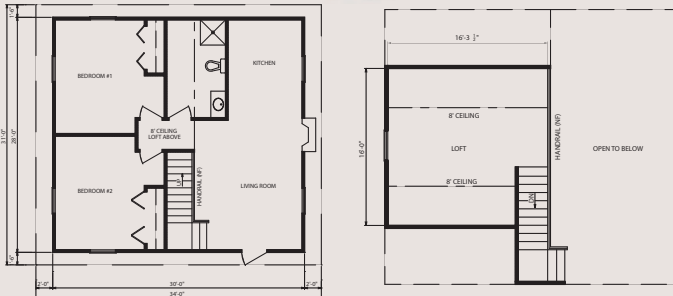

Cumberland: 28' x 30', 840 sq. ft.

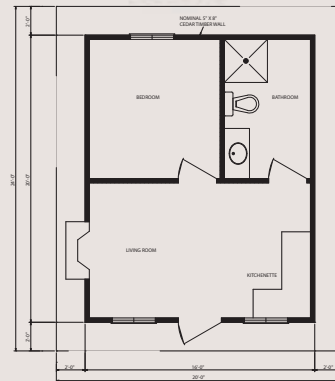

Fairmont: 16' x 20', 320 sq. ft.

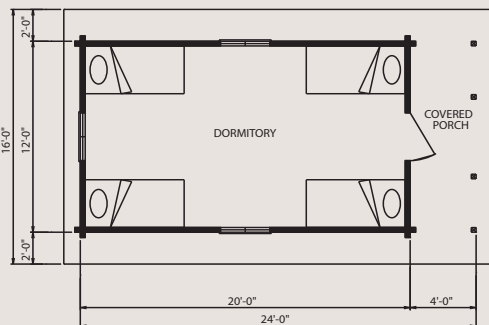

Huntington: 12' x 20', 240 sq. ft.

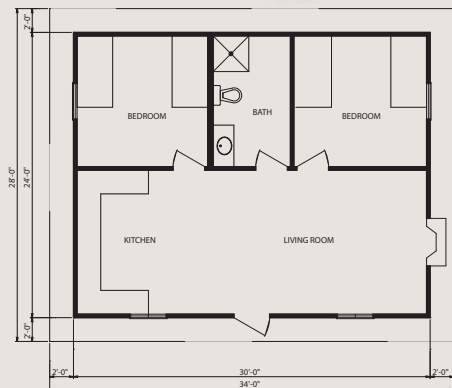

Lakewood: 24' x 30', 720 sq. ft.

Cabin Layouts

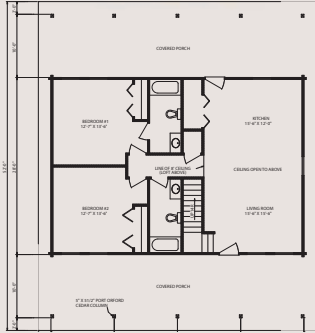

Montana: 28' x 40', 1,120 sq. ft.

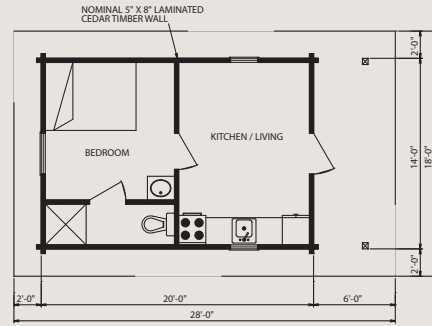

Northland: 14' x 20', 280 sq. ft.

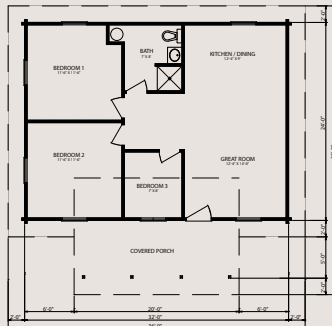

Saratoga: 24' x 32', 768 sq. ft.

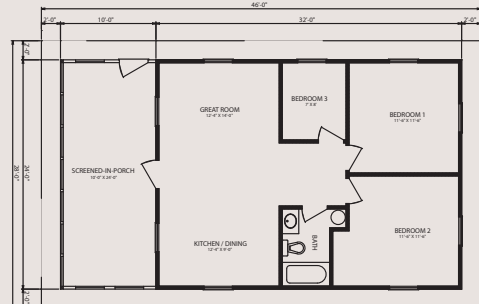

Summer Ridge: 24' x 42', 1,008 sq. ft.

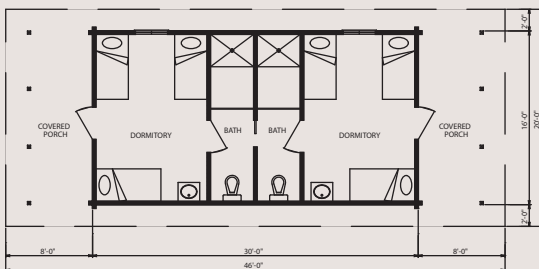

Timberland: 16' x 30', 480 sq. ft.

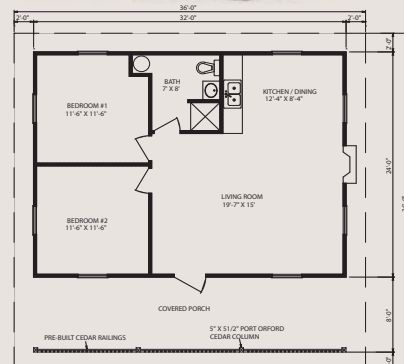

Woodridge: 24' x 32', 768 sq. ft.

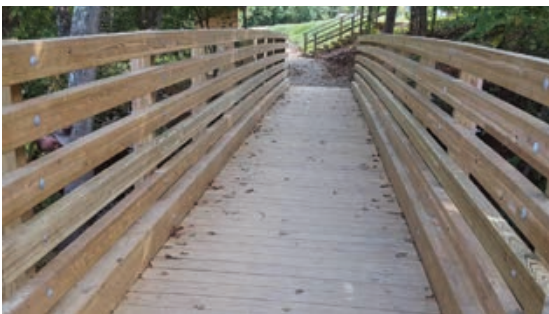

Bridges

Design excellence and uncompromising quality speaks for itself in CFP's glulam bridge systems. CFP's bridges blend in beautifully with their natural surroundings, designed for use on: golf courses, waterways, parks, bike and equestrian trails, wildlife areas and business complexes nationwide.

Solid posts, rugged laminated stringers and diaphragms are spaced for maximum load capacity and structural integrity.

Detailed drawings make installation simple and fast.

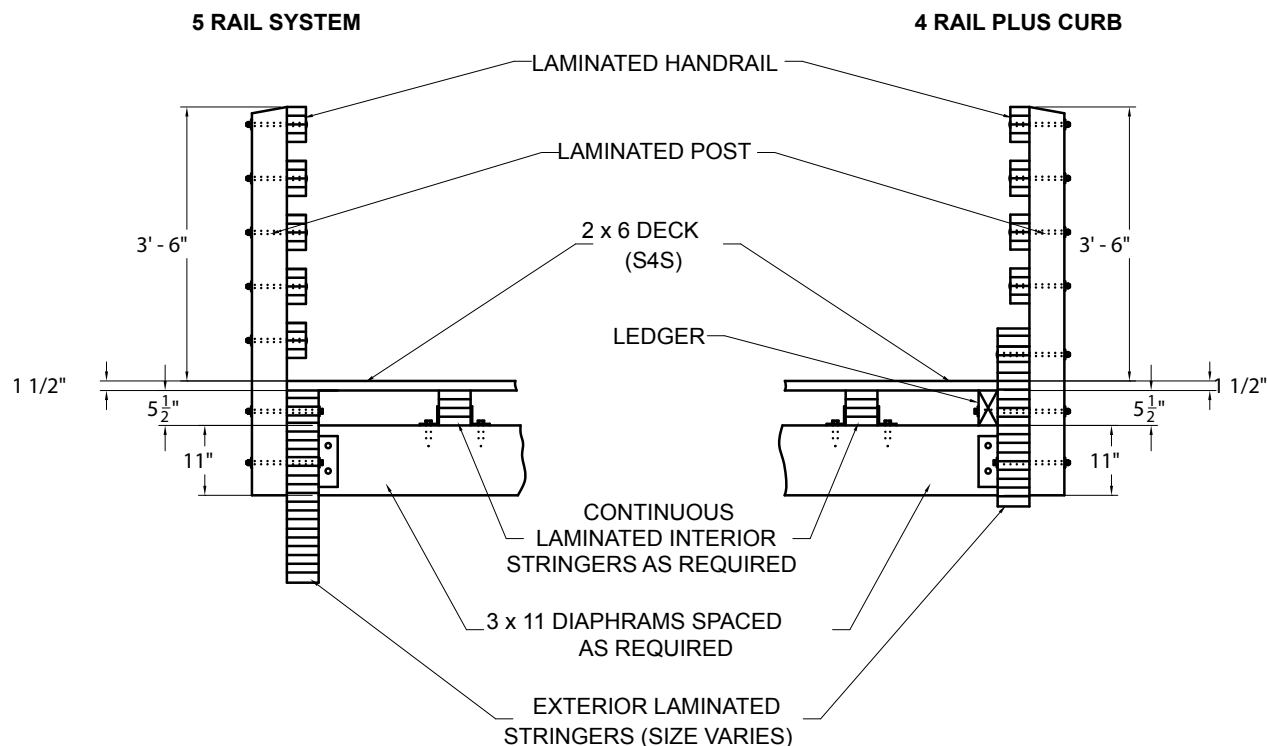

Built on a reputation that spans many generations!

- Pre-engineered in 4', 6', and 8' clear deck widths with spans ranging from 16' to 80'
- All standard wood components (except decking) are glulam Southern Yellow Pine, decking is 2" x 6" SYP
- Hardware used to connect glulam components is galvanized steel
- Bridges 4' and 6' wide and up to 60' in length are shipped completely assembled
- Bridges 8' wide to 60' in length are shipped with railings assembled but not attached
- Bridge lengths over 60' are shipped to the site, knocked down and unassembled



Options: 5-Rail or 4-Rail Plus Curb Railing Option • Various Deck Widths • Various Bridge Spans • Flat or Cambered Bridge Style

Wood & Wood Look Site Amenities

- Galvanized Steel or Powder Coated Steel Frame
 - Available in a variety of colors
 - Choose from Wood or Recycled Plastic
- Choose from Premier, Classic and Everyday Series

Benches



Series P - BW
Featuring Ipe Wood



Series C - BW



Series E - BW

Benches available in 4', 6' or 8' lengths

Tables



Series P - TW



Series C - TW



Series E - TW

Tables available in multiple sizes, extended lengths and ADA accessible

Receptacles & Extras



Series C - RW-S
32 gallon



Series C - RW-C
32 gallon



Series C - G300
Grill

Receptacles come with lid and plastic liner

Steel Site Amenities

- All items are powder coated steel
 - Available in a variety of colors
 - Series E has Thermoplastic coating
- Choose from Premier, Classic and Everyday Series

Benches



Series P - BS



Series C - BS



Series E - BS



Series E - BS-NB

Benches available in 6' & 8' sizes

Tables



Series P - TS



Series E - TS-C



Series E - TS-S



Series E - TS-R

Tables available in multiple sizes, extended lengths and ADA accessible

Receptacles & Extras



Series P - RS
32 gallon



Series C - RS
32 gallon



Series E - RS
32 gallon



Series C - BR
Bike Rack

All Receptacles come with a lid and plastic liner

Wood Color Options & Selections

Colors shown are only representative

29 Gauge Metal Roofing Color Options



Shingle Color Options



Stain Color Options



Cedar Wall Corner Style Selections

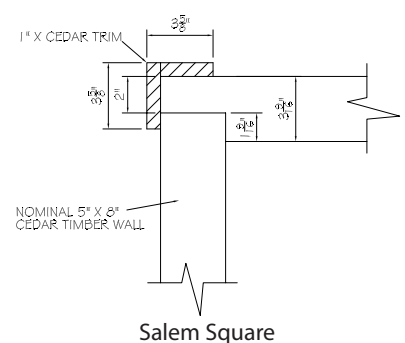
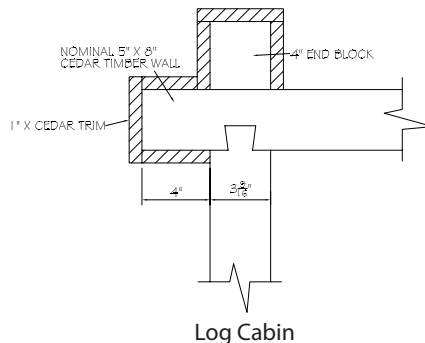
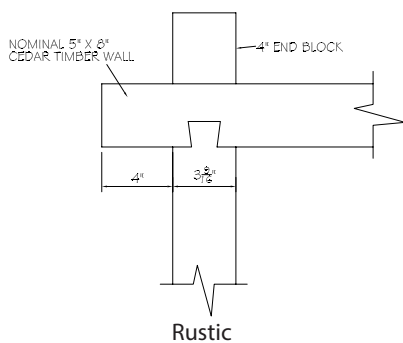

Steel Color Options & Selections

Colors shown are only representative

Powder Coat & Metal Roofing Color Options

STANDARD COLORS



DEEP TONE PREMIUM COLORS (Additional Costs Will Apply)



METALLIC COLORS (Additional Costs Will Apply)



Ornamentation Selections

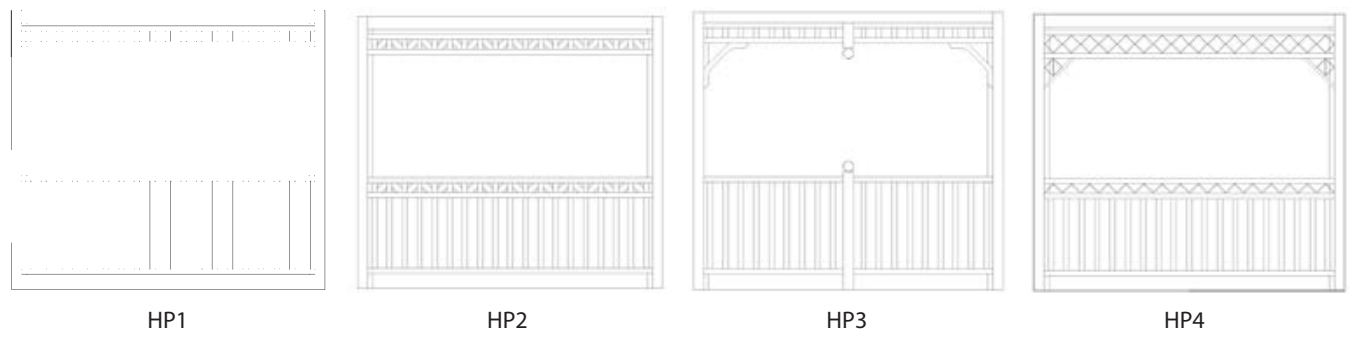



Covering All Your Needs Since 1964!

Cedar Forest Products

P.O. Box 145

West Olive, MI 49460

Office: 616.433.6008

Toll Free: 800.552.9495

www.cedarforestproducts.com

info@cedarforestproducts.com