

**KOMPAN**<sup>®</sup>  
FitACTIVE





## PLAYFUL LIVING

At KOMPAN, we're obsessed with getting you moving.

We are passionate about creating modern, healthy environments that are engaging, dynamic, and most importantly, fun — regardless of your age or ability. By designing a wide variety of play, sports, and fitness equipment for every stage of life, we strive to keep everyone playing. This catalog includes our FitACTIVE collection of products, which promote fun, active lifestyles that support physical literacy.

- Overview • 2
- Product Guide • 4
- FREEGAME • 6
- CORE Fitness • 16
- X-ERCISE • 22
- Safety & Warranty • 36
- Environmental Statement • 37
- Product Index • 38



Recycled  
Supporting responsible  
use of forest resources  
Cert no. SW-COC-001563  
www.fsc.org  
© 1996 Forest Stewardship Council



by Hemlock Printers www.hemlock.com/zero

Besides building healthy communities, we're also committed to building a healthy environment. That's why all our catalogs are carbon neutral, using 100% post-consumer paper. Help us out by recycling this catalog when you're ready — or better yet, share it with someone else.



## Play Matters

Forty years ago in a village in Denmark, a magical twist of fate changed the world of play forever. A dynamic young sculptural artist discovered that children found his colorful outdoor sculptures irresistible to play on. On that day, KOMPAN was born from the heart of an artist. The joy his creations gave children became the passion that still drives us today.

At KOMPAN, we are completely focused on strengthening our children and families by creating exceptional spaces for play — for every age and ability. Our designs continue to attract kids and adults alike, bringing them together to build a generation of play. After four decades, we see the positive impact we're making in communities worldwide.

### Design Matters

Innovation is a cornerstone of our company. KOMPAN's innovative approach to design, combined with our commitment to high-quality materials and processes, helps to ensure that KOMPAN equipment will provide a lasting benefit to every customer. We recognize the value of beautiful design and we strive to develop products that combine modern aesthetics with limitless play value. KOMPAN is recognized as a global leader in quality design and has won awards from the IDSA, Red Dot, and more. Spaces that feature our products are special. They show how we value parks as a resource. They show how we respect nature. And they show how we treasure childhood and families.

### Play Value Matters

At KOMPAN, we understand that the real value to any playground is the richness of the experiences children have when playing. To make sure we fulfill our promise to children, we proactively conduct our own research and product evaluations through the KOMPAN Play Institute (KPI), an international network of child and playground experts. KPI's research on play and its ability to identify important trends in child development ensures our products reflect what kids are doing today. KPI strives to build sustainable communities through sustainable kids.

### Environment Matters

Playgrounds should be as good for the environment as they are for the kids who play on them. Our innovative approach to sustainability reaches every corner of our company. From the carbon-neutral catalog you're holding to the eco-friendly products on its pages, KOMPAN leads the industry in sustainable play. KOMPAN was the first playground company to attain ISO 14001 Certification, to ban the use of PVC in all its products, and to use cogeneration to power its offices. Our play value pledge means every resource utilized in making a KOMPAN product is put to good use and nothing goes to waste. We minimize our impact on the environment, and maximize our impact in the world around us.

### Inclusion Matters

Everyone has a right to play, regardless of ability. Our approach to accessibility goes beyond meeting ADA requirements. We work together with mobility advocates to design playgrounds that get everyone to look beyond limitations to find playful moments together. We call this inclusive design: people of differing abilities playing together — each finding appropriate challenges, interaction and excitement.

## FREEGAME



FREEGAME Courts • 8



FRE2210 FREEGAME Goal 3M • 10



FRE2211 FREEGAME Goal 5M • 10



FRE2212 FREEGAME Goal 9M • 11



FRE2213 FREEGAME Goal 12M • 11



FRE3000 Stargazer • 12

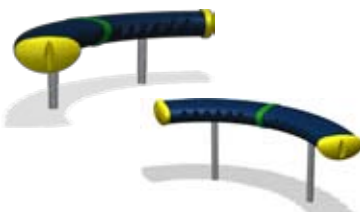

FRE3010/3011 Crescent 40, Crescent 60 • 12

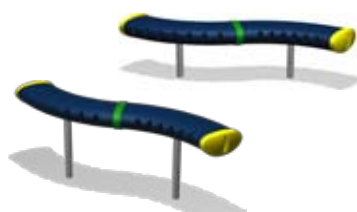

FRE3012/3013 CometTail 40, CometTail 60 • 13



FRE3020 Basketball Hoop • 13

## CORE Fitness



ELE5900105 Ab Stretcher • 18



ELE5900106 Parallel Bars • 18



ELE5900107 Push-Up Bars • 19



ELE5900108 Stretching Post • 19



ELE5900109 Pull-Up Bars • 20



ELE5900112 Sit-Up Bench, High • 20



ELE5900113 Sit-Up Bench, Low • 21

## X-ERCISE



KPX120 Free Runner • 26



KPX121 Sit-Up Bench • 26



KPX122 Flex Wheel • 27



KPX123 Body Flexer • 27



KPX124 Body Flexer w/ Roof • 28



KPX125 Cross Trainer • 28



KPX126 Leg Lift Station • 29



KPX127 Leg Lift Station w/ Roof • 29



KPX128 Upper Body Trainer • 30



KPX129 Cycle Trainer • 30



KPX220 Dual Flex • 31



KPX221 Dual Flex w/ Roof • 31



KPX222 Core Cyclor • 32



KPX223 Core Cyclor w/ Roof • 32



KPX224 Flex Trainer • 33



KPX225 Cardio • 33



KPX226 Cardio w/ Roof • 34



KPX320 Complete Cardio • 34



KPX323 Complete Body Toner • 35



KPX324 Complete Body Toner w/ Roof • 35

# FREEGAME

The name FREEGAME says it all — a place to explore the imagination of active play with free range. Our courts offer an opportunity for children, adolescents, and adults to be physically active in multiple ways. FREEGAME provides easy access for everyone, including children and adults with mobility impairments.

FREEGAME courts support multiple sports activities, easily transforming the space from a basketball court to a soccer field, volleyball court and more. Other game options include football, field hockey, tennis, badminton, pickleball, capture-the-flag — it's all up to your imagination. FREEGAME brings together communities in a whole new way.



# FREEGAME COURTS

## Standard courts include:

- Integrated basketball and soccer goals
- Sport posts at midfield
- Sport net

## Additional options include:

- Backside basketball hoops
- Mini side goals
- Metal mesh panel
- Freestanding basketball hoop
- Service opening

*Optional components are incorporated through custom configurations.*

*Surfacing not included.*

### 8 Standard Court Sizes

#### FRE2110 • FREEGAME Court 12x20 M

Actual Dimensions: 39' x 67' 8" 2720 ft<sup>2</sup>  
11.9 x 20.62 m 240 m<sup>2</sup>

#### FRE2111 • FREEGAME Court 12x24 M

Actual Dimensions: 39' x 80' 9" 3280 ft<sup>2</sup>  
11.9 x 24.62 m 288 m<sup>2</sup>

#### FRE2112 • FREEGAME Court 15x26 M

Actual Dimensions: 48' 3" x 87' 4" 4224 ft<sup>2</sup>  
14.7 x 26.62 m 390 m<sup>2</sup>

#### FRE2113 • FREEGAME Court 15x30 M

Actual Dimensions: 48' 3" x 100' 6" 4896 ft<sup>2</sup>  
14.7 x 30.62 m 450 m<sup>2</sup>

#### FRE2114 • FREEGAME Court 16x28 M

Actual Dimensions: 52' 2" x 96' 11" 4888 ft<sup>2</sup>  
15.9 x 28.62 m 448 m<sup>2</sup>

#### FRE2115 • FREEGAME Court 16x32M

Actual Dimensions: 52' 2" x 107' 5616 ft<sup>2</sup>  
15.9 x 32.62 m 512 m<sup>2</sup>

#### FRE2116 • FREEGAME Court 19x36 M

Actual Dimensions: 61' 4" x 120' 2" 7440 ft<sup>2</sup>  
18.7 x 36.62 m 684 m<sup>2</sup>

#### FRE2117 • FREEGAME Court 20x40 M

Actual Dimensions: 65' 4" x 133' 3" 8844 ft<sup>2</sup>  
19.9 x 40.62 m 800 m<sup>2</sup>



Freestanding FREGAME Goal 3M · FRE2210



**Best user age: 5+**

**Space required:**  
Sufficient space shall be provided between all adjacent structures and individual equipment to allow use and circulation.

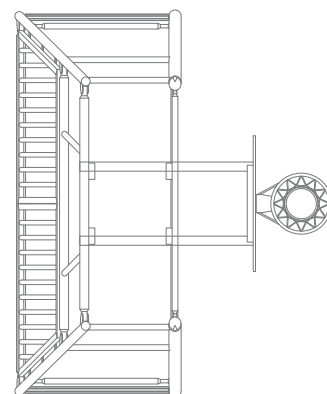

Freestanding FREGAME Goal 9M · FRE2212



**Best user age: 5+**

**Space required:**  
Sufficient space shall be provided between all adjacent structures and individual equipment to allow use and circulation.

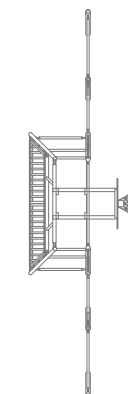

Freestanding FREGAME Goal 6M · FRE2211



**Best user age: 5+**

**Space required:**  
Sufficient space shall be provided between all adjacent structures and individual equipment to allow use and circulation.

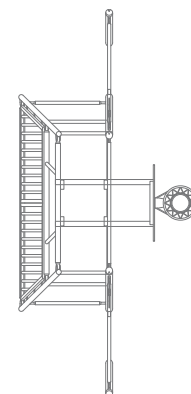

Freestanding FREGAME Goal 12M · FRE2213



**Best user age: 5+**

**Space required:**  
Sufficient space shall be provided between all adjacent structures and individual equipment to allow use and circulation.

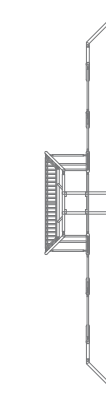

Stargazer · FRE3000



**Best user age: 5+**

**Space required:**  
Sufficient space shall be provided between all adjacent structures and individual equipment to allow use and circulation.

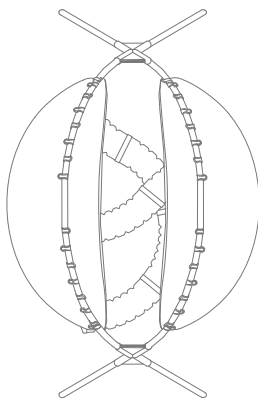

CometTail 40, CometTail 60 · FRE3012/3013



**Best user age: 5+**

**Space required:**  
Sufficient space shall be provided between all adjacent structures and individual equipment to allow use and circulation.

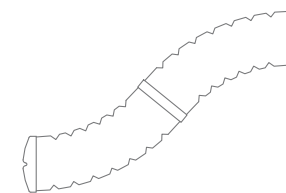

Crescent and CometTail benches can be combined to create unique seating designs.

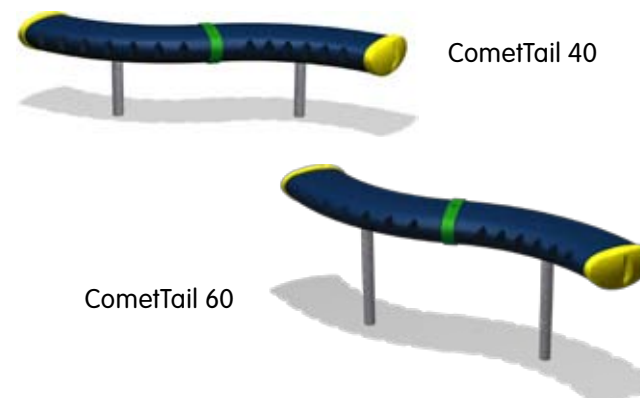

Crescent 40, Crescent 60 · FRE3010/3011



**Best user age: 5+**

**Space required:**  
Sufficient space shall be provided between all adjacent structures and individual equipment to allow use and circulation.

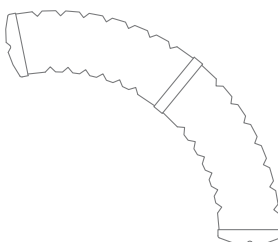

Crescent and CometTail benches can be combined to create unique seating designs.

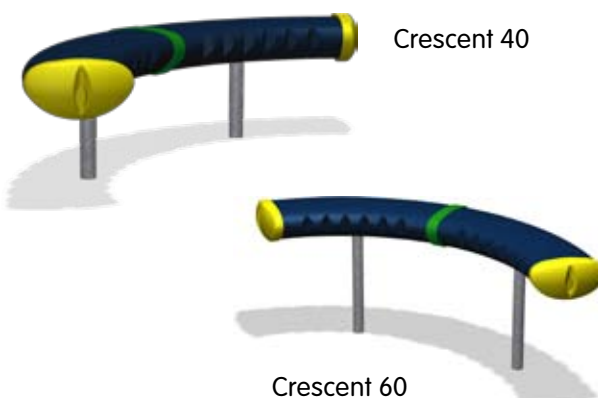

**Best user age: 5+**

**Space required:**  
Sufficient space shall be provided between all adjacent structures and individual equipment to allow use and circulation.

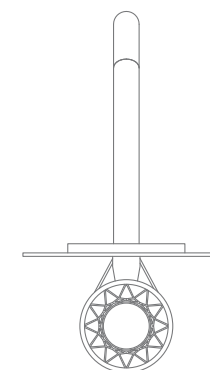

Basketball Hoop with Nylon Net · FRE3020









## CORE Fitness

CORE Fitness products are designed with weight-bearing physical activities in mind. Such physical activities are great training for all ages. Lunges, pull-ups, push-ups, step-ups, tricep dips, and balance training, are just a few of the many exercises you can perform. These activities will help tone legs, arms, and abdomen, while burning calories.

Weight-bearing physical activity reduces the rate of bone loss, which is associated with osteoporosis. Regular physical activities that include weight-bearing movement support strength, flexibility, balance, coordination, and can help reduce the risk of injuries.

CORE Fitness provides a range of versatile activities for a complete workout.

Ab Stretcher · ELE5900105



**Best user age:** 15+

**Activity & Benefits:**

This space-saving structure provides a variety of fitness options, allowing for a nearly complete workout.

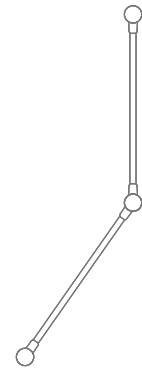

Parallel Bars · ELE5900106



**Best user age:** 15+

**Activity & Benefits:**

Great for bar dips to build lower pectorals, triceps, and frontal deltoids using your own weight.

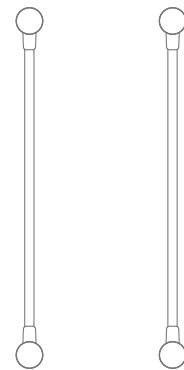

Push-Up Bars · ELE5900107



**Best user age:** 15+

**Activity & Benefits:**

Push-ups, tricep dips, and stretching are just a few of the exercises this equipment facilitates.



Stretching Post · ELE5900108



**Best user age:** 15+

**Activity & Benefits:**

Stretch before and after your workout with the help of this foot step and hand grip.

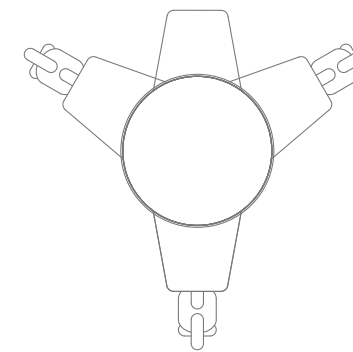

Pull-Up Bars · ELE5900109



**Best user age:** 15+

**Activity & Benefits:**

Using just your body weight, pull-ups and chin-ups will strengthen the muscles of your fingers, forearms, biceps, triceps, shoulders, back and core.



Sit-Up Bench, High · ELE5900112



**Best user age:** 15+

**Activity & Benefits:**

Increase your sit-up capabilities with a steeper inclined sit-up bench to activate your core muscles. Use the foot hold to improve form.

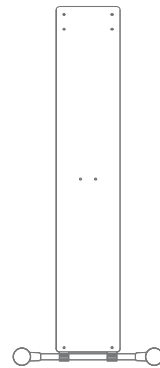

Sit-Up Bench, Low · ELE5900113

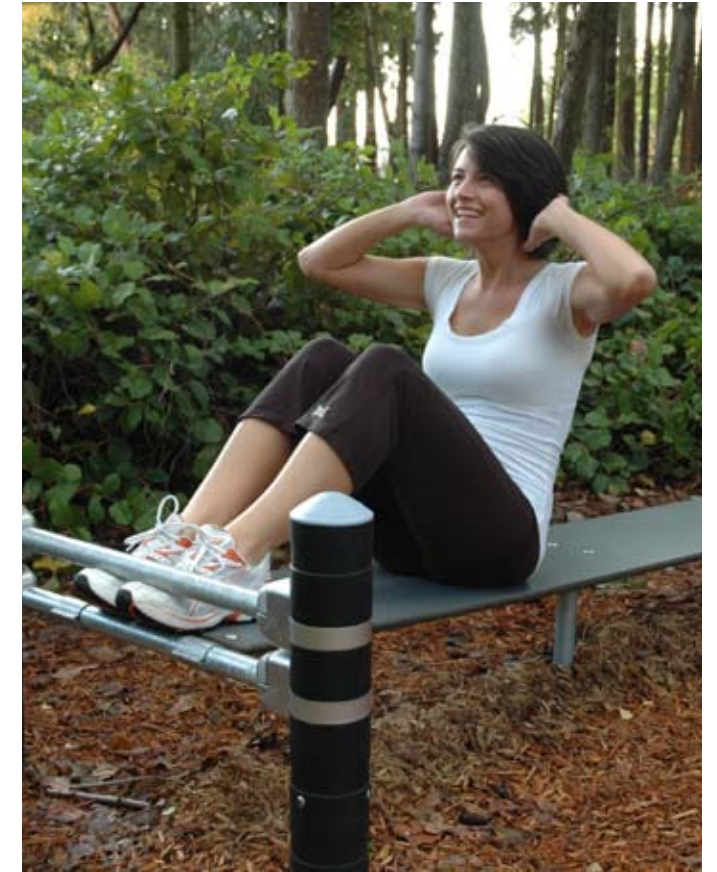

**Best user age:** 15+

**Activity & Benefits:**

Build a solid core with inclined sit-ups. The foot hold assists with stabilization for better form.

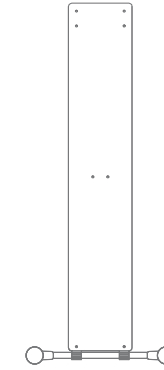



## X-ERCISE

Together with experts who specialize in sports and physical training, we have developed X-ERCISE specifically to meet the needs of today's busy schedules.

X-ERCISE is focused on strong and flexible training of the heart, lungs, and muscles, providing a comfortable and convenient way to increase and maintain a healthy lifestyle. Aerobic workouts, flexibility, and muscular strength training for all levels of abilities can be found in this fitness product line.

X-ERCISE is built with robust, high quality materials. Its modern design gives it an urban, transparent appearance that compliments any outdoor environment.

## A Healthier Tomorrow

Health has become a growing concern around the world. Every day we are introduced to new information on how obesity has become an epidemic. At KOMPAN, we take these concerns seriously and we believe we can help to make a difference.

To encourage more people to take an active interest in their health, we have made it our mission to introduce a flexible outdoor fitness system that allows people to engage in varied, easily accessible exercises within their community.

X-ERCISE offers a complete circuit training workout that appeals to users of all fitness levels. Circuit training has been cited as one of the best workout routines for an overall improvement in physical health. Cycling through a series of several strength-building structures and stretching equipment provides a full-body workout.

Benefits of circuit training with X-ERCISE:

- Provides a full-body workout
- Increases muscular fitness
- Easily adapts to your workout needs
- Increases oxygen consumption
- Incorporates strength stability
- Improves flexibility
- Builds endurance
- Strengthens cardio fitness



Upper body workout



Core and tricep workout



Stretching



Cardio workout



Full-body workout

Free Runner · KPX120



**Best user age:** 15+

**Activity & Benefits:**

Receive all the benefits of running, but at low impact to protect the joints. Aerobic activity helps promote overall health and fitness.

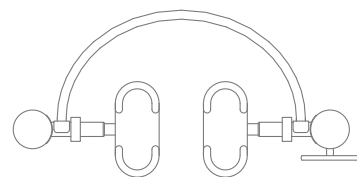

Flex Wheel · KPX122



**Best user age:** 15+

**Activity & Benefits:**

Improve oblique strength and shoulder mobility in order to improve posture.

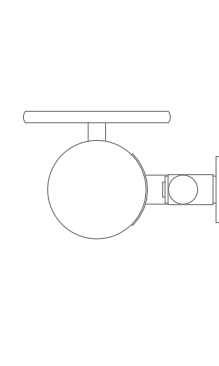

Sit-Up Bench · KPX121



**Best user age:** 15+

**Activity & Benefits:**

Sit-ups strengthen your abdominal wall while improving muscle strength and endurance. A stronger core can help prevent back problems.

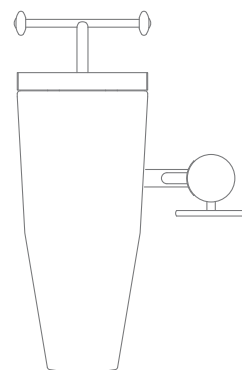

Body Flexer · KPX123



**Best user age:** 15+

**Activity & Benefits:**

Strengthen your abdominal cavity and internal and external obliques, improving posture and balance.

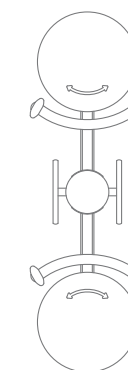

Body Flexer with Roof · KPX124

**Best user age:** 15+

**Activity & Benefits:**

Be protected from the elements while strengthening your abdominal cavity and internal and external obliques, improving posture and balance.

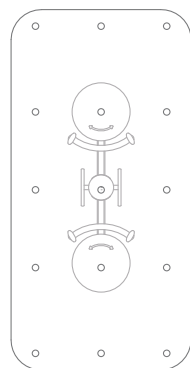

Cross Trainer · KPX125

**Best user age:** 15+

**Activity & Benefits:**

Boost your cardiovascular fitness in order to improve body composition, health and overall quality of life.

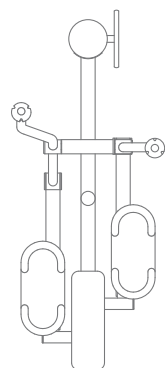

Leg Lift Station · KPX126

**Best user age:** 15+

**Activity & Benefits:**

A great workout to improve both your back and abdominal muscles. This activity will stabilize your center of gravity and improve balance.

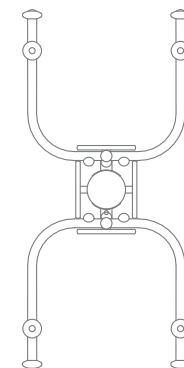

Leg Lift Station with Roof · KPX127

**Best user age:** 15+

**Activity & Benefits:**

A great space to work out and improve both your back and abdominal muscles. This activity will stabilize your center of gravity and improve your balance.

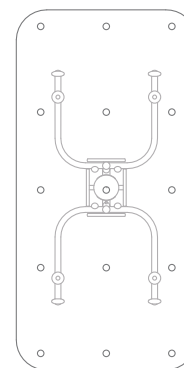



Upper Body Trainer · KPX128



**Best user age:** 15+

**Activity & Benefits:**

Alternating between chin-ups and pull-ups will strengthen your bicep and shoulder muscles.

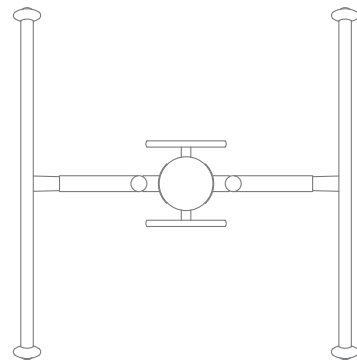

Dual Flex · KPX220



**Best user age:** 15+

**Activity & Benefits:**

Build a stronger core with this complete oblique and abdomen strengthening tool to improve posture and balance.

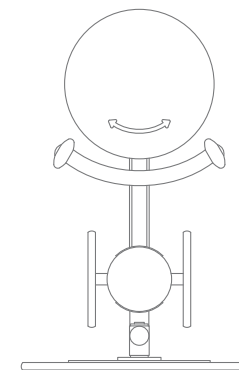

Cycle Trainer · KPX129



**Best user age:** 15+

**Activity & Benefits:**

This recumbent exercise bike is easy on joints and will allow for effective warm-ups and aerobic exercise.

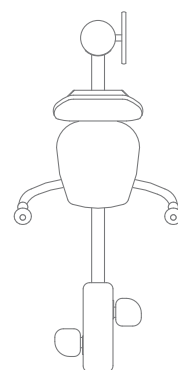

Dual Flex with Roof · KPX221



**Best user age:** 15+

**Activity & Benefits:**

Build a stronger core with this complete oblique and abdomen strengthening tool to improve posture and balance, all while in the comfort of shade.

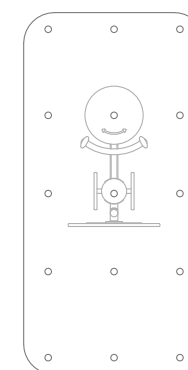

Core Cycler · KPX222



**Best user age:** 15+  
**Activity & Benefits:**  
 Perfect for an effective warm-up. Then switch to strengthening your abdominal wall and improving your core.

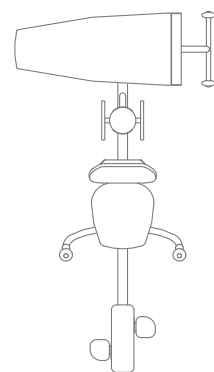

Core Cycler with Roof · KPX223



**Best user age:** 15+  
**Activity & Benefits:**  
 Protect yourself from the elements with this effective warm-up and core strengthening structure. A proper warm-up will ensure a safe workout.

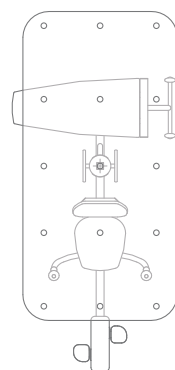

Flex Trainer · KPX224

**Best user age:** 15+  
**Activity & Benefits:**  
 Switch between chin-ups and pull-ups to build your upper body muscles, then take a turn at strengthening your internal and external obliques.

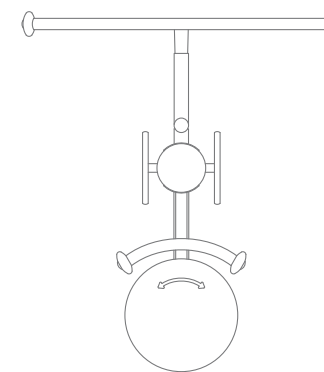

Cardio · KPX225

**Best user age:** 15+  
**Activity & Benefits:**  
 You'll be sure to get an effective aerobic workout with this structure through low-impact running and full-body cardio.

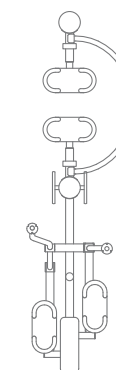

Cardio with Roof · KPX226



**Best user age:** 15+

**Activity & Benefits:**

Get a complete aerobic workout through running and full-body cardio, all while protecting yourself from the elements.

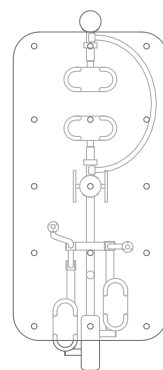

Complete Cardio · KPX320



**Best user age:** 15+

**Activity & Benefits:**

Three equipment choices in one provide a complete cardio workout to increase your heart rate and burn calories.



Complete Body Toner · KPX323

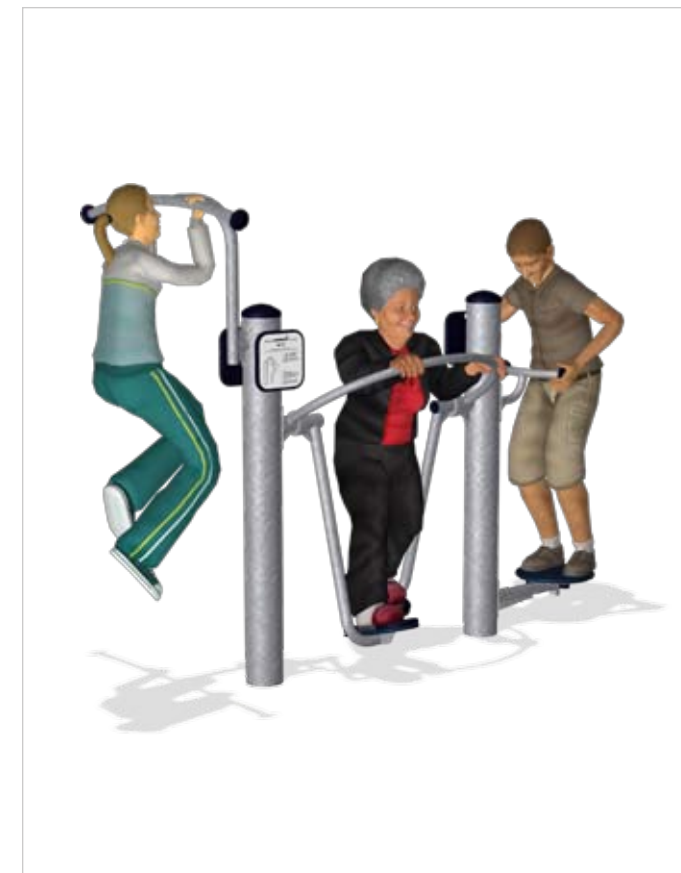

**Best user age:** 15+

**Activity & Benefits:**

This complete body toner works your entire body to improve overall health and fitness.

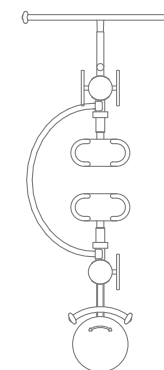

Complete Body Toner with Roof · KPX324

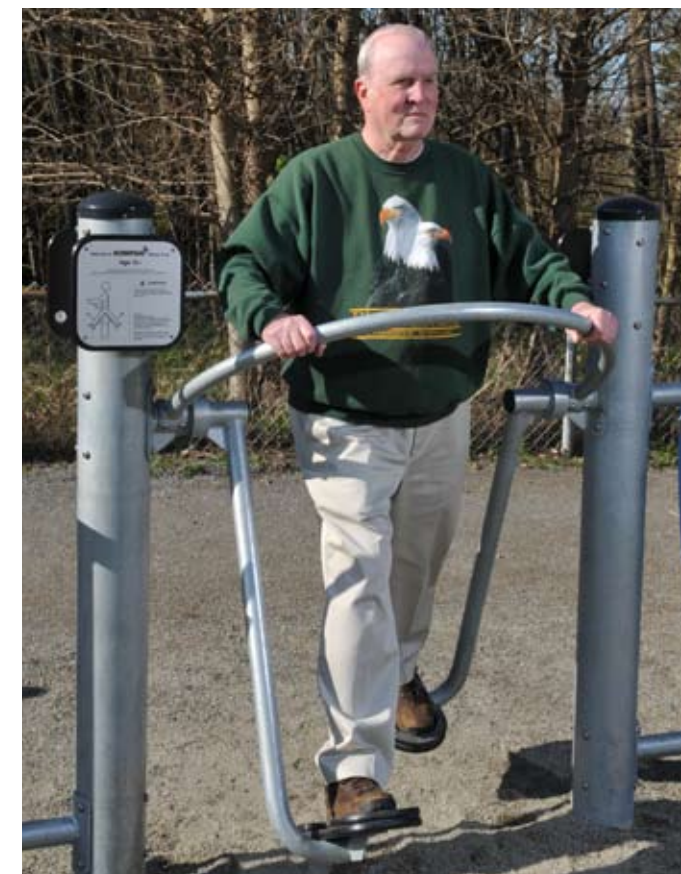

**Best user age:** 15+

**Activity & Benefits:**

Protect yourself from the elements and still work out your entire body to improve overall health and fitness.

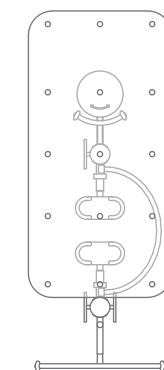

## Safety & Warranty

### Safety and Quality

KOMPAN believes in making users feel safe and secure and able to play freely while still providing products that challenge children. The balance between safety and the level of challenge depends on the intended user group and their level of imagination and ability to predict risk. We believe a certain level of challenge and risk is essential in order to provide interesting playgrounds where children are enabled to develop important future life skills and physical and psychological abilities.

Our goal is to develop innovative products both within our own philosophy on safety and within the highest playground safety standards. At KOMPAN, we consider safety first. We minimize risks through sound design, thorough testing, and use of only the highest quality materials.

The International Standards Organization (ISO) has certified KOMPAN to ISO 9001. This means that quality assurance measures are implemented at every step of our production process, from raw material sourcing to delivery of your KOMPAN equipment on site.

As an international supplier of playground equipment, KOMPAN products are manufactured using high quality materials and processes to withstand the harshest conditions and climates. KOMPAN's innovative approach to design, combined with our commitment to quality, helps to ensure that KOMPAN equipment will provide a lasting benefit to every customer.

### Warranty

#### 1. Classification of warranty by material type.

##### 20 years

Against failure due to material or production defects on HDPE and HPL panels, and galvanized structural parts such as poles, cross beams, floor frames and top brackets.

##### 10 years

Against failure due to material or production defects on all other galvanized parts, non-painted steel and metal parts, and hollow plastic parts.

##### 5 years

Against failure due to material or production defects on springs, painted metal parts, ball bearing assemblies, and net constructions.

##### 2 years

Against failure due to material or production defects on movable plastic and metal parts and all ICON electrical components.

#### 2. Warranty coverage of damaged parts.

The warranty covers all KOMPAN products. Such damaged parts will be replaced by KOMPAN and will be delivered to the customer's address free of charge. ICON electrical components will be installed free of charge by a qualified contractor.

#### 3. Warranty coverage applies only if products have been properly installed and maintained.

The warranty is not effective if products have not been installed properly according to the instructions provided by KOMPAN, or maintained correctly according to the KOMPAN Maintenance Manual.

#### 4. No coverage for wear, tear, misuse, vandalism.

Warranty does not cover normal wear and tear, surface corrosion on metal parts, discolored surfaces and other cosmetic issues or failures due to misuse or vandalism.

## Environmental Statement

Playgrounds should be as good for the environment as they are for the kids who play on them. Our innovative approach to sustainability reaches every corner of our company. From the carbon-neutral catalog you're holding to the eco-friendly products on its pages, KOMPAN leads the industry in sustainable play. KOMPAN was the first playground company to attain ISO 14001 Certification, to ban the use of PVC in all its products, and to use cogeneration to power its offices. Our play value pledge means every resource utilized in making a KOMPAN product is put to good use and nothing goes to waste. We minimize our impact on the environment, and maximize our impact in the world around us.

Here's a closer look at the ways we're making a difference.

### KOMPAN Manufacturing • ISO 14001

KOMPAN is certified to the International Standards Association 14001, which requires the highest level of environmental management of manufacturing. As a global supplier of playground equipment, KOMPAN is committed to meeting the most rigorous standards for environmentally responsible manufacturing. KOMPAN's environmental policy has earned the company the Green Business Award.

### Recycled Materials

KOMPAN utilizes recycled materials whenever feasible. Currently, our aluminum components are manufactured with recycled materials and our posts are comprised of 30% recycled steel. The HDPE plastic panels used in FREEGAME and X-ERCISE utilize 70% recycled material. KOMPAN products are manufactured from materials that can be recycled at the end of their lifespan, reducing landfill waste.

### Polyvinyl Chloride (PVC) and Phthalates Free

KOMPAN is proud to say that our products have always been PVC and phthalates free. Polyvinyl Chloride (PVC) is a plastic that is mainly used in making pipes for plumbing. However, many playground manufacturers use a softened form of PVC to coat metal parts, such as decks, handrails, and hand rings. Not only does the production of PVC release dioxins, which are known to be linked to cancer, but the process of making PVC soft involves the use of phthalates,

which have been linked to potential health hazards. The use of phthalates in children's products is enough of a concern that legislation has been enacted at both state and federal levels banning its use.

Besides being harmful to our bodies, PVC is also harmful to the environment in which we live. Recycling PVC is difficult, and it usually ends up in landfills.

### Limited Use of Paint

Powder coating paint is a common method of adding color to playground equipment. When the surface coating chips, however, the metal is exposed to corrosive elements and will require added maintenance. One of KOMPAN's philosophies is to minimize the amount of paint on our equipment and instead use solid-colored materials. Besides reducing the maintenance hours that would normally be necessary to reapply colored coatings to parts, this practice also eliminates the need to purchase and store harmful chemicals.

### Leadership in Energy and Environmental Design

KOMPAN supports the Leadership in Energy and Environmental Design (LEED) program and can assist in achieving LEED certification for your project. KOMPAN equipment utilizes recycled materials, which can be applied toward attaining LEED credits 4.1 and 4.2.

### Forest Stewardship Council Certification

To reduce the use of trees, all but two of KOMPAN's products are made from durable and recyclable metals and plastics. When printing marketing material, KOMPAN is sure to always use paper material that comes from a responsibly managed forest certified by the standards of The Forest Stewardship Council (FSC). The catalog you currently hold is composed of 100% FSC certified, recycled paper. For more information, visit <http://www.fscus.org>.



- FRE2110-17 FREEGAME Courts • 8
- FRE2210 FREEGAME Goal 3M • 10
- FRE2211 FREEGAME Goal 6M • 10
- FRE2212 FREEGAME Goal 9M • 11
- FRE2213 FREEGAME Goal 12M • 11
- FRE3000 Stargazer • 12
- FRE3010 Crescent 40 • 12
- FRE3011 Crescent 60 • 12
- FRE3012 CometTail 40 • 13
- FRE3013 CometTail 60 • 13
- FRE3020 Freestanding Basketball Hoop • 13
- ELE5900105 Ab Stretcher • 18
- ELE5900106 Parallel Bars • 18
- ELE5900107 Push-Up Bars • 19
- ELE5900108 Stretching Post • 19
- ELE5900109 Pull-Up Bars • 20
- ELE5900112 Sit-Up Bench, High • 20
- ELE5900113 Sit-Up Bench, Low • 21
- KPX120 Free Runner • 26

- KPX121 Sit-Up Bench • 26
- KPX122 Flex Wheel • 27
- KPX123 Body Flexer • 27
- KPX124 Body Flexer w/ Roof • 28
- KPX125 Cross Trainer • 28
- KPX126 Leg Lift Station • 29
- KPX127 Leg Lift Station w/ Roof • 29
- KPX128 Upper Body Trainer • 30
- KPX129 Cycle Trainer • 30
- KPX220 Dual Flex • 31
- KPX221 Dual Flex w/ Roof • 31
- KPX222 Core Cyclor • 32
- KPX223 Core Cyclor w/ Roof • 32
- KPX224 Flex Trainer • 33
- KPX225 Cardio • 44
- KPX226 Cardio w/ Roof • 34
- KPX320 Complete Cardio • 34
- KPX323 Complete Body Toner • 35
- KPX324 Complete Body Toner w/ Roof • 35

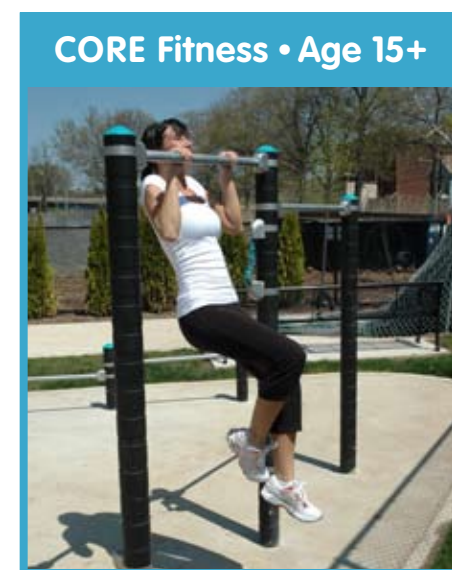
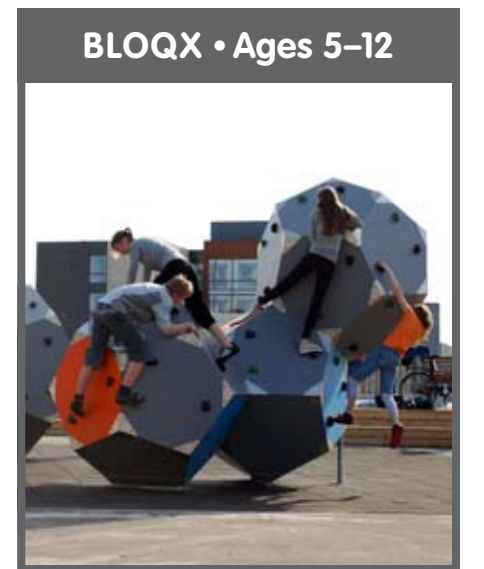



930 Broadway, Tacoma, WA 98402

Phone • 800.426.9788

Fax • 866.943.6254

Email • [contact@kompan.com](mailto:contact@kompan.com)

Web • [kompan.com](http://kompan.com)

Material • [requestmaterials.com](http://requestmaterials.com)